



**Ermis**<sup>®</sup>  
MedTech



# ACCESSORIES

FOR CSSD



# Ermis®

From the world center of the Medical Technology as the successor of Ermis Medizintechnik e.K., we supply our customers worldwide since 1998 with high quality products for the CSSD. Thereby, we manage on both market segments for the reusable products and for single use products. As an experienced supplier we offer a wide range of high quality as well as customized products for the hospitals worldwide, individually designed items, from customized sets through to complex elements. The continuous development and close co-operation with our users lead each time to extension of our product line and our know-How in the medical technology.



<i>About Ermis</i>	<b>2</b>
<i>Container accessories (seals, labels and filters)</i>	<b>4</b>
<i>Mesh baskets and accessories</i>	<b>29</b>
<i>Protective clothing</i>	<b>85</b>
<i>Brushes, cleaner and maintenance</i>	<b>96</b>
<i>Tip guards, sterilization packaging and silicone products</i>	<b>111</b>
<i>Documentation labels</i>	<b>130</b>
<i>Tapes and identification / Lettering</i>	<b>165</b>
<i>Quality monitoring</i>	<b>186</b>
<i>Stainless Steel Tools</i>	<b>207</b>
<i>Kirschner wires</i>	<b>224</b>
<i>Trays and containers</i>	<b>229</b>
<i>Sealers</i>	<b>237</b>
<i>OR consumables and patient care</i>	<b>242</b>

You find our current Certificates and  
General Terms and Conditions on our website:  
[www.ermis-medizintechnik.de](http://www.ermis-medizintechnik.de)

The offered products can be concerned as Ermis 's own product as well as trading products.

Our products will be marked according to the International Regulatory Requirements.

Our deliveries and services are directed at entrepreneurs within the meaning of § 14 BGB (German Civil Code),  
not at end consumers within the meaning of § 13 BGB.

**Paper seals, without indicator, flap width 3.0 mm**

REF		pack. unit
92-01010	Seal without indicator, for safety lock of Aesculap containers. Simple to use and millionfold approved. Environment-friendly, internationally patented.	1000 pieces
	white size: 100 x 18 mm	



**Paper seals, with steam indicator, flap width 2.0 and 3.0 mm**

	white size: 105 x 30 mm	
92-02638	flap width: 2.0 mm	1000 pieces
92-01003	flap width: 3.0 mm	1000 pieces



**Paper seals , without indicator, flap width 3.5 mm**

92-02665	Seal without indicator, for safety lock of Aesculap containers. Simple to use and millionfold approved. Environment-friendly, internationally patented.	500 pieces
	white size: 70 x 38 mm	



**Paper seals, with steam indicator, flap width 4.0 mm**

	white with documentation field with flap	
92-01004	size: 117 x 38 mm	500 pieces
92-04120	size: 132 x 38 mm	500 pieces



**Paper seals, with steam indicator, single self-adhesive**  
**REF**

pack. unit

 92-01005      white  
 size: 117 x 38 mm  
 with documentation field  
 with flap

500 pieces

**Paper seals, with steam indicator, flap width 3.0 mm, single self-adhesive**

 92-04179      white  
 size: 145 x 35 mm  
 with documentation field

750 pieces

**Paper seals for Aesculap containers, with documentation field, single self-adhesive**

 white  
 with steam indicator  
 inserting side: right

 92-01006      size: 35 x 74 mm  
 92-04113      size: 35 x 80 mm

 1000 pieces  
 1000 pieces

**Paper seals for Aesculap containers, blank, single self-adhesive**

 92-04114      white  
 size: 35 x 74 mm  
 inserting side: right

1000 pieces



## Paper seals for Aesculap containers, with documentation field, non-adhesive

REF		pack. unit
92-01008	white size: 35 x 74 mm with steam indicator	1000 pieces

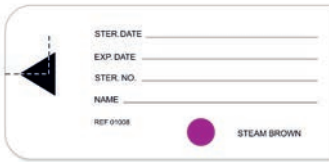

## Paper seals for Aesculap containers, inserting side left

	white size: 35 x 74 mm with steam indicator with documentation field	
92-04108	non-adhesive	1000 pieces
92-01009	single self-adhesive	1000 pieces

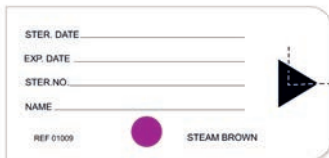

## Paper seal on reel for Aesculap containers, single self-adhesive

92-04109	white size: 78 x 32.6 mm with steam indicator with documentation field pieces per reel: 1500 pieces dispensed on the outside core diameter: 76 mm	1 reel
----------	---	--------



## Foil labels, glue removable without residues, single self-adhesive

	for sealing containers	
	size: 102 x 25 mm pieces per reel: 500 pieces dispensed on the outside heat resistant: up to 134 °C core diameter: 76 mm	
92-01001	with steam indicator	1 reel
92-01002	without indicator	1 reel





**Security labels, green, single self-adhesive**

REF pack. unit

---

92-04281      After approximately 15 minutes the security effect of the glue will occur.

1 reel

with imprint: "Sicherheitssiegel / Security Seal"  
 size: 90 x 30 mm  
 numbering: serially  
 reel width: 102 mm  
 pieces per reel: 500 pieces  
 dispensed on the inside  
 core diameter: 76 mm



**Security seal made of plastic**

---

92-02639      yellow      1000 pieces

length: 290 mm  
 numbering: continuous  
 working length: 210 mm



**Universal plastic seals UniLock**

---

	without indicator	
92-01240	blue	1000 pieces
92-01241	green	1000 pieces
92-01242	white	1000 pieces
92-01243	red	1000 pieces
92-01244	yellow	1000 pieces
	with steam indicator	
92-01245	blue	1000 pieces
92-01246	green	1000 pieces
92-01247	white	1000 pieces
92-01248	red	1000 pieces
92-01249	yellow	1000 pieces



Universal plastic seals UniLock XL, with large flap

REF		pack. unit
	also suitable to affix labels onto the seals	
	without indicator	
 92-01250	blue	1000 pieces
92-01251	green	1000 pieces
92-01252	white	1000 pieces
92-01253	red	1000 pieces
92-01254	yellow	1000 pieces
92-02514	violet	1000 pieces
92-02515	orange	1000 pieces
	with steam indicator	
92-01255	blue	1000 pieces
92-01256	green	1000 pieces
92-01257	white	1000 pieces
92-01258	red	1000 pieces
92-01259	yellow	1000 pieces
92-02516	violet	1000 pieces
92-02517	orange	1000 pieces

Universal plastic seals

	amongst others also suitable for Aesculap and Wagner containers	
	without indicator	
 92-01025	blue	1000 pieces
92-01026	red	1000 pieces
92-01027	green	1000 pieces
92-01028	yellow	1000 pieces
92-01029	white	1000 pieces
92-02624	orange	1000 pieces
92-02625	violet	1000 pieces
	with steam indicator	
92-01220	blue	1000 pieces
92-01221	red	1000 pieces
92-01233	green	1000 pieces
92-01238	yellow	1000 pieces
92-01239	white	1000 pieces

Universal plastic seals

	Plastic seal "AW" for Aesculap and Wagner containers	
	without indicator	
92-02612	red	1000 pieces
92-02613	blue	1000 pieces
92-02614	green	1000 pieces
92-02615	yellow	1000 pieces
92-02661	white	1000 pieces
92-02662	black	1000 pieces



**Universal plastic seals**



REF		pack. unit
	with steam indicator	
92-02632	red	1000 pieces
92-02633	blue	1000 pieces
92-02634	green	1000 pieces
92-02635	yellow	1000 pieces
92-02663	white	1000 pieces

**Universal plastic seals "2011", amongst others also suitable for Aesculap and Wagner containers**



	without indicator	
92-02500	blue	1000 pieces
92-02501	green	1000 pieces
92-02502	white	1000 pieces
92-02503	red	1000 pieces
92-02504	yellow	1000 pieces
92-02505	neon-yellow	1000 pieces
92-02506	neon-orange	1000 pieces
	with steam indicator	
92-02507	blue	1000 pieces
92-02508	green	1000 pieces
92-02509	white	1000 pieces
92-02510	red	1000 pieces
92-02511	yellow	1000 pieces
92-02512	neon-yellow	1000 pieces
92-02513	neon-orange	1000 pieces



## Universal plastic seals

	REF		pack. unit
	92-01262	without indicator blue	1000 pieces
	92-01263	red	1000 pieces
	92-01264	green	1000 pieces
	92-01265	yellow	1000 pieces
	92-01266	with steam indicator blue	1000 pieces
	92-01267	red	1000 pieces
	92-01268	green	1000 pieces
	92-01269	yellow	1000 pieces

## Universal plastic seals

	92-01270	without indicator red	1000 pieces
	92-01271	green	1000 pieces
	92-01272	yellow	1000 pieces
	92-01273	blue	1000 pieces
	92-01274	with steam indicator red	1000 pieces
	92-01275	green	1000 pieces
	92-01276	yellow	1000 pieces
	92-01277	blue	1000 pieces

## Universal plastic seals, 1-2-3 seal

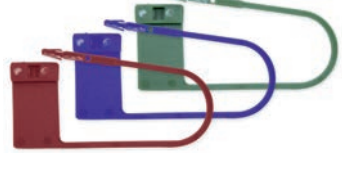
	92-02600	without indicator natural colour	1000 pieces
	92-02602	white	1000 pieces
	92-02604	yellow	1000 pieces
	92-02606	red	1000 pieces
	92-02608	blue	1000 pieces
	92-02610	green	1000 pieces
	92-02601	with steam indicator natural colour	1000 pieces
	92-02603	white	1000 pieces
	92-02605	yellow	1000 pieces
	92-02607	red	1000 pieces
	92-02609	blue	1000 pieces
	92-02611	green	1000 pieces

**Universal plastic seals, with predetermined breaking point, length 195 mm**

REF		pack. unit
	without indicator	
92-01204	blue	1000 pieces
92-02641	red	1000 pieces
92-02643	yellow	1000 pieces
92-02660	green	1000 pieces
	with steam indicator	
92-01205	blue	1000 pieces

**Universal plastic seals**

	without indicator	
92-01014	blue	1000 pieces
92-01216	red	1000 pieces
92-01217	green	1000 pieces
92-01218	yellow	1000 pieces
92-01219	black	1000 pieces
	with steam indicator	
92-01013	blue	1000 pieces
92-01212	red	1000 pieces
92-01213	green	1000 pieces
92-01214	yellow	1000 pieces
92-01215	black	1000 pieces

**Plastic seals, for Aesculap containers**

	without indicator	
92-01015	light blue	1000 pieces
92-01016	green	1000 pieces
92-01017	white	1000 pieces
92-01018	red	1000 pieces
92-01019	yellow	1000 pieces
92-01206	black	1000 pieces
	with steam indicator	
92-01210	light blue	1000 pieces
92-01222	green	1000 pieces
92-02621	white	1000 pieces
92-01211	red	1000 pieces
92-02616	yellow	1000 pieces

**Plastic seals, for Aesculap containers**

	without indicator	
92-01020	blue	1000 pieces
92-01021	green	1000 pieces
92-01022	white	1000 pieces
92-01023	red	1000 pieces
92-01024	yellow	1000 pieces
92-01234	orange	1000 pieces
92-01236	violet	1000 pieces



**Plastic seals, for Aesculap containers**

REF		pack. unit	
	92-01228	with steam indicator blue	1000 pieces
	92-01229	green	1000 pieces
	92-01230	white	1000 pieces
	92-01231	red	1000 pieces
	92-01232	yellow	1000 pieces
	92-01235	orange	1000 pieces
	92-01237	violet	1000 pieces

**Plastic seals, for Martin containers**

	92-01011	white without indicator	1000 pieces
	92-01012	with steam indicator	1000 pieces

**Plastic seals, for Martin containers (Miniset)**

	92-02630	red without indicator	1000 pieces
	92-02631	with steam indicator	1000 pieces

**Plastic seals, for Martin containers (Microstop)**

	92-02636	red without indicator	500 pieces
	92-02637	with steam indicator	500 pieces

**Container labels for Aesculap containers, blank**  
**REF**

pack. unit

size: 39.5 x 68 mm

92-04102	non-adhesive	1000 pieces
92-04106	single self-adhesive	1000 pieces

**Container labels for Aesculap containers**

size: 35 x 80 mm

non-adhesive

92-01400	with steam indicator, with documentation field	1000 pieces
92-04184	without indicator, blank	1000 pieces

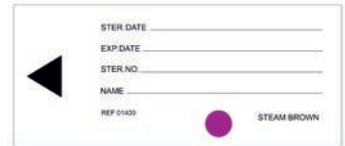
**Container labels for Aesculap containers, with steam indicator (4 bars)**

92-01135	size: 39.5 x 68 mm	1000 pieces
----------	--------------------	-------------

with documentation field

non-adhesive

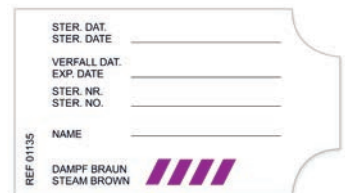
**Container labels for Aesculap containers, with steam indicator (dot)**

92-01136	size: 39.5 x 67 mm	1000 pieces
----------	--------------------	-------------

with documentation field

single self-adhesive

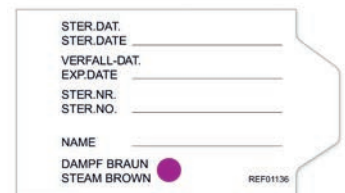

## Container labels for Aesculap containers, with steam indicator (imprint "Steril")

REF		pack. unit
92-04104	with frame  size: 39.5 x 67 mm with documentation field single self-adhesive	1000 pieces

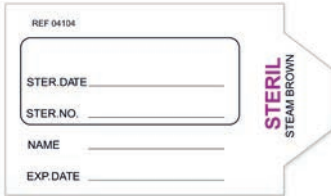

## Container labels for Aesculap containers, with steam indicator (imprint "Steril")

92-04118	size: 39.5 x 67 mm with documentation field single self-adhesive	1000 pieces
----------	--	-------------

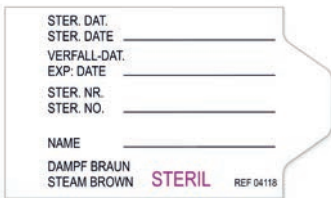

## Container labels for Aesculap containers

92-04000	size: 18 x 60 mm with steam indicator with documentation field single self-adhesive	1000 pieces
----------	--	-------------



## Container labels for Aesculap containers, with imprint: "Entsorgung" / "Disposal"

92-01123	size: 39 x 65 mm without indicator with documentation field non-adhesive	1000 pieces
----------	---	-------------

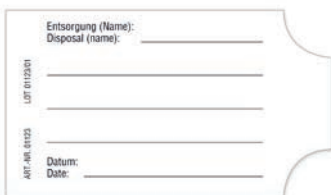

**Container labels for Aesculap containers**

REF		pack. unit
92-04005	size: 18 x 50 mm with steam indicator with documentation field non-adhesive	1000 pieces

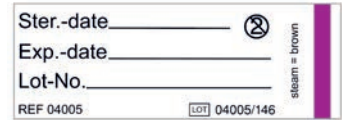
**Container labels for Martin containers**

	size: 35 x 50 mm with steam indicator with documentation field	
92-01137	non-adhesive	1000 pieces
92-01125	single self-adhesive	1000 pieces

**Container labels for Martin containers**

92-01138	size: 46 x 50 mm with steam indicator with documentation field non-adhesive	1000 pieces
----------	--	-------------

**Container labels for Martin containers**

92-01139	size: 46 x 50 mm with steam indicator with documentation field single self-adhesive	1000 pieces
----------	--	-------------

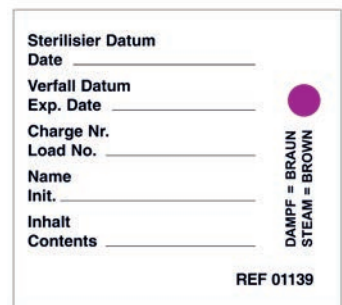

## Container labels for Martin containers

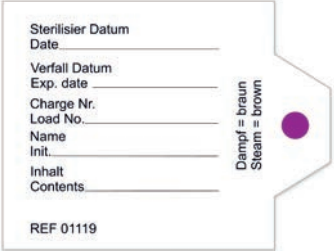
REF		pack. unit
		
	size: 46 x 60 mm with steam indicator with documentation field	
92-01119	non-adhesive	1000 pieces
92-01122	single self-adhesive	1000 pieces

## Container labels for Martin containers, for Microstop containers

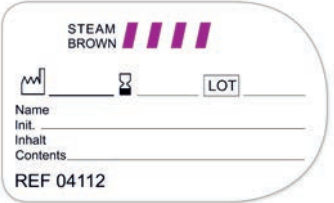
		
92-04112	size: 39 x 63 mm with steam indicator with documentation field single self-adhesive	1000 pieces

## Container labels for Medicon containers

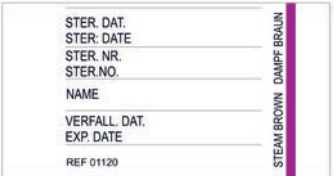
		
92-01120	size: 36 x 67 mm with steam indicator with documentation field single self-adhesive	1000 pieces

## Container labels for Medicon containers, blank

		
92-04123	size: 36 x 67 mm non-adhesive	1000 pieces



**Container labels for Medicon containers**

REF \_\_\_\_\_ pack. unit \_\_\_\_\_

92-01121      size: 36 x 64 mm  
 with steam indicator  
 with documentation field  
 non-adhesive

1000 pieces

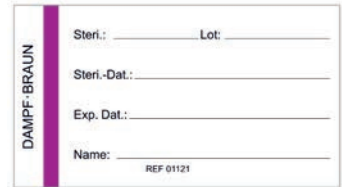
**Container labels for Wagner containers**

92-01133      size: 40 x 59 mm  
 with steam indicator  
 with documentation field  
 non-adhesive

1000 pieces

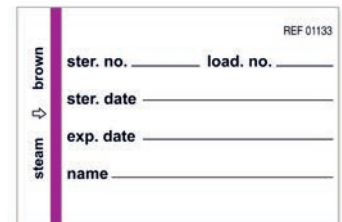
**Container labels for Wagner containers**

92-01134      size: 40/10 x 59 mm  
 with steam indicator  
 with documentation field  
 single self-adhesive

1000 pieces

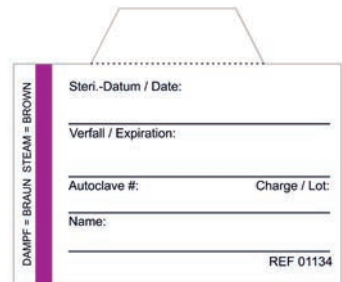
**Container labels for Wagner containers**

92-01169      size: 40 x 59/15 mm  
 with steam indicator  
 with documentation field  
 single self-adhesive

1000 pieces



## Container label for Geuder containers

REF		pack. unit
92-04067	size: 23 x 60 mm with steam indicator with documentation field single self-adhesive	1000 pieces



## Container labels for CBM containers

92-04116	size: 39.5 x 55 mm with steam indicator with documentation field non-adhesive	1000 pieces
----------	--	-------------



## Container labels

	with steam indicator with documentation field non-adhesive	
92-01118	size: 39.5 x 67 mm	1000 pieces
92-01116	size: 38.0 x 67 mm	1000 pieces



## Container labels, blank

	size: 46 x 60 mm without indicator	
92-01124	non-adhesive	1000 pieces
92-04105	single self-adhesive	1000 pieces





### Container paper filters for Aesculap containers according to ISO 11607-1 / for single use

REF		pack. unit
	white filter imprint: with functional information diameter: 190 mm round filter hole punching: central Ø 6 mm	
92-01140	with steam indicator	500 pieces
92-01152	with steam indicator, packed at 100 pcs.	500 pieces
92-01141	without indicator	500 pieces



### Container paper filters for Aesculap containers according to ISO 11607-1 / for single use

REF		pack. unit
	miniset filter  white rectangular filter size: 118 x 235 mm with pointed corners	
92-01148	filter imprint: with functional information with steam indicator	200 pieces
92-01186	filter imprint: blank, without indicator	200 pieces



### Container paper filters for Aesculap containers according to ISO 11607-1 / for single use

REF		pack. unit
92-01317	white filter imprint: with functional information rectangular filter size: 170 x 230 mm with pointed corners with steam indicator	500 pieces



### Container paper filters for Aesculap containers according to ISO 11607-1 / for single use

REF		pack. unit
	white rectangular filter size: 230 x 230 mm	
92-01153	filter imprint: with functional information with bevelled corners with steam indicator	500 pieces
92-01142	filter imprint: blank with bevelled corners without indicator	500 pieces
92-01149	filter imprint: blank with pointed corners without indicator	500 pieces



**Container filter made of non-woven material according to ISO 116071 / for single use**

REF

pack. unit



92-01368

blue  
filter imprint: blank  
diameter: 92 mm  
round fleece filter  
without indicator

1000 pieces

**Container filter made of non-woven material for Martin containers, according to ISO 116071 / for single use**



92-01145

blue  
filter imprint: with functional information  
rectangular fleece filter  
size: 225 x 225 mm  
hole punching: 2  
with pointed corners  
with steam indicator

500 pieces

**Container filter made of non-woven material for H<sub>2</sub>O<sub>2</sub>-sterilization / for single use**



92-01378

blue  
filter imprint: blank  
diameter: 190 mm  
round fleece filter  
hole punching: central Ø 6 mm  
without indicator

500 pieces

**Container paper filters for Martin containers according to ISO 11607-1 / for single use**



92-01330

white  
filter imprint: with functional information  
rectangular filter  
size: 104 x 104 mm  
hole punching: with oblong hole  
with rounded corners  
with steam indicator

250 pieces

**Container paper filters for Martin containers according to ISO 11607-1 / for single use**

REF		pack. unit
92-01158	white filter imprint: with functional information rectangular filter size: 110 x 240 mm hole punching: 2 with pointed corners with steam indicator	200 pieces

**Container paper filters for Martin containers according to ISO 11607-1 / for single use**

	white filter imprint: with functional information rectangular filter with steam indicator	
92-01143	size: 180 x 270 mm	500 pieces
92-01321	size: 180 x 255 mm	500 pieces

**Container paper filter for Wagner containers according to ISO 11607-1 / for single use**

92-01355	white filter imprint: with functional information diameter: 190 mm round filter hole punching: central Ø 10 mm with steam indicator	500 pieces
----------	--	------------

**Container paper filter for Wagner containers according to ISO 11607-1 / for single use**

92-01369	white filter imprint: with functional information diameter: 75 mm round filter hole punching: central Ø 10 mm with steam indicator	1000 pieces
----------	---	-------------



## Container paper filter for Wagner containers according to ISO 11607-1 / for single use

REF

pack. unit

92-01363

white  
filter imprint: with functional information  
rectangular filter  
size: 245 x 400 mm  
with pointed corners  
with steam indicator

500 pieces



## Container paper filter for Wagner containers according to ISO 11607-1 / for single use

92-01323

white  
filter imprint: with functional information  
rectangular filter  
size: 96 x 212 mm  
with pointed corners  
with steam indicator

250 pieces



## Container paper filters for Wagner containers according to ISO 11607-1 / for single use

92-01314

white  
filter imprint: with functional information  
rectangular filter  
size: 145 x 205 mm  
with pointed corners  
with steam indicator

100 pieces



## Container paper filters according to ISO 11607-1 / for single use

92-01357

white  
filter imprint: with functional information  
rectangular filter  
size: 170 x 255 mm  
with pointed corners  
with steam indicator

500 pieces



**Container paper filters according to ISO 11607-1 / for single use**

REF		pack. unit
92-01356	white filter imprint: with functional information rectangular filter size: 200 x 435 mm with pointed corners with steam indicator	100 pieces

**Container paper filters according to ISO 11607-1 / for single use**

92-01315	white filter imprint: with functional information rectangular filter size: 240 x 240 mm with bevelled corners with steam indicator	250 pieces
----------	---	------------

**Container paper filters according to ISO 11607-1 / for single use**

92-01327	white filter imprint: with functional information rectangular filter size: 240 x 540 mm with steam indicator with pointed corners	100 pieces
----------	--	------------

**Container paper filters according to ISO 11607-1 / for single use**

92-01367	white filter imprint: with functional information rectangular filter size: 250 x 350 mm with pointed corners with steam indicator	200 pieces
----------	--	------------



## Container paper filters according to ISO 11607-1 / for single use

REF		pack. unit
92-01157	 <p>white filter imprint: blank diameter: 130 mm round filter hole punching: 2 without indicator</p>	200 pieces

## Container paper filters according to ISO 11607-1 / for single use

92-01318	 <p>white filter imprint: blank rectangular filter hole punching: 4 without indicator</p>	50 pieces
92-01167	with rounded corners size: 132 x 358 mm	100 pieces
92-01305	size: 165 x 245 mm	500 pieces
92-01304	size: 210 x 210 mm	100 pieces
92-01304	size: 210 x 490 mm	100 pieces
92-01345	with pointed corners size: 160 x 280 mm	200 pieces

## Container paper filters according to ISO 11607-1 / for single use

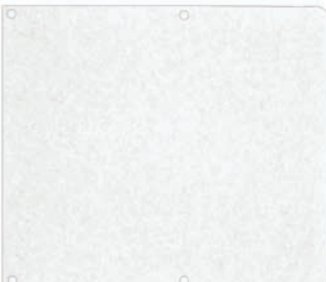
92-01306	 <p>rectangular filter size: 220 x 255 mm hole punching: 4 with 2 rounded and 2 pointed corners without indicator</p>	100 pieces
----------	--	------------

## Container paper filters according to ISO 11607-1 / for single use, without indicator

	rectangular filter	
92-01303	size: 40 x 155 mm	250 pieces
92-01301	size: 40 x 285 mm	250 pieces
92-01313	size: 85 x 140 mm	200 pieces
92-01302	size: 85 x 155 mm	250 pieces
92-01300	size: 85 x 285 mm	200 pieces
92-01377	size: 100 x 200 mm	100 pieces
92-01366	size: 100 x 230 mm	250 pieces
92-01352	size: 100 x 300 mm	250 pieces
92-01351	size: 110 x 170 mm	250 pieces
92-01336	size: 112 x 225 mm	250 pieces
92-01333	size: 120 x 120 mm	250 pieces



**Container paper filters according to ISO 11607-1 / for single use, without indicator**

REF		pack. unit
92-01380	size: 120 x 285 mm	100 pieces
92-01370	size: 130 x 215 mm	250 pieces
92-01311	size: 145 x 205 mm	200 pieces
92-01371	size: 165 x 245 mm	250 pieces
92-01183	size: 180 x 260 mm	250 pieces
92-01194	size: 180 x 270 mm	250 pieces
92-01361	size: 185 x 390 mm	500 pieces
92-01354	size: 200 x 400 mm	250 pieces
92-01358	size: 200 x 550 mm	250 pieces
92-01383	size: 210 x 390 mm	250 pieces
92-01196	size: 210 x 490 mm	100 pieces
92-01198	size: 230 x 540 mm	250 pieces
92-01144	size: 240 x 240 mm	250 pieces
92-01181	size: 240 x 540 mm	100 pieces
92-01359	size: 300 x 400 mm	500 pieces

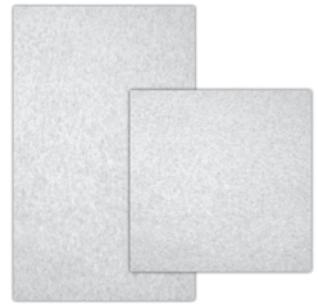
**Textile filter with zz-seam, unbleached, without holes**

rectangular filter

92-01672	size: 95 x 205 mm	50 pieces
92-01675	size: 95 x 210 mm	50 pieces
92-01104	size: 110 x 200 mm	50 pieces
92-01655	size: 110 x 270 mm	50 pieces
92-01177	size: 115 x 230 mm	50 pieces
92-01096	size: 115 x 365 mm	50 pieces
92-01660	size: 120 x 170 mm	50 pieces
92-01172	size: 120 x 225 mm	50 pieces
92-01687	size: 120 x 240 mm	50 pieces
92-01668	size: 120 x 330 mm	50 pieces
92-01662	size: 130 x 280 mm	50 pieces
92-01666	size: 130 x 320 mm	50 pieces
92-01673	size: 130 x 325 mm	50 pieces
92-01674	size: 130 x 345 mm	50 pieces
92-01678	size: 135 x 175 mm	50 pieces
92-02312	size: 140 x 400 mm	50 pieces
92-01077	size: 155 x 280 mm	50 pieces
92-01084	size: 160 x 400 mm	50 pieces
92-01696	size: 165 x 385 mm	50 pieces
92-01178	size: 170 x 230 mm	50 pieces
92-01072	size: 170 x 360 mm	50 pieces
92-01671	size: 170 x 400 mm	50 pieces
92-01688	size: 180 x 240 mm	50 pieces
92-01079	size: 180 x 260 mm	50 pieces
92-01663	size: 190 x 370 mm	50 pieces
92-01080	size: 200 x 300 mm	50 pieces
92-01063	size: 205 x 490 mm	50 pieces
92-01099	size: 205 x 205 mm	50 pieces
92-02300	size: 210 x 270 mm	50 pieces
92-01653	size: 210 x 490 mm	50 pieces
92-01074	size: 210 x 540 mm	50 pieces
92-01693	size: 212 x 226 mm	50 pieces
92-01089	size: 218 x 218 mm	50 pieces
92-01681	size: 220 x 235 mm	50 pieces
92-02308	size: 220 x 340 mm	50 pieces
92-02303	size: 220 x 490 mm	50 pieces



## Textile filter with zz-seam, unbleached, without holes

REF		pack. unit
92-01690	size: 220 x 500 mm	50 pieces
92-01680	size: 225 x 225 mm	50 pieces
92-01170	size: 230 x 230 mm	50 pieces
92-01073	size: 235 x 530 mm	50 pieces
92-01091	size: 240 x 240 mm	50 pieces
92-01695	size: 240 x 520 mm	50 pieces
92-01651	size: 240 x 540 mm	50 pieces
92-01093	size: 250 x 530 mm	50 pieces
92-01085	size: 260 x 540 mm	50 pieces
92-01111	size: 270 x 350 mm	50 pieces
92-01087	size: 290 x 590 mm	50 pieces
92-01092	size: 330 x 330 mm	50 pieces
92-02307	size: 440 x 160 mm	50 pieces



## Textile filter with zz-seam, unbleached, without holes

	round filter	
92-01103	diameter: 110 mm	50 pieces
92-01686	diameter: 120 mm	50 pieces
92-01076	diameter: 130 mm	50 pieces
92-01685	diameter: 185 mm	50 pieces
92-02301	diameter: 190 mm	50 pieces
92-02302	diameter: 210 mm	50 pieces
92-01684	diameter: 220 mm	50 pieces
92-01078	diameter: 230 mm	50 pieces
92-01652	diameter: 280 mm	50 pieces
92-02304	diameter: 300 mm	50 pieces
92-02311	diameter: 380 mm	50 pieces



## Textile filter with zz-seam, unbleached, with 2 holes

	rectangular filter	
92-01171	size: 218 x 218 mm	50 pieces
92-01682	size: 130 x 360 mm	50 pieces



## Textile filter with zz-seam, unbleached, with 4 holes

	rectangular filter	
92-02309	size: 83 x 365 mm	50 pieces
92-01677	size: 90 x 195 mm	50 pieces
92-02305	size: 105 x 205 mm	50 pieces
92-01683	size: 110 x 220 mm	50 pieces
92-01656	size: 120 x 180 mm	50 pieces
92-01179	size: 120 x 270 mm	50 pieces
92-01661	size: 135 x 328 mm	50 pieces
92-01670	size: 140 x 150 mm	50 pieces
92-01108	size: 165 x 250 mm	50 pieces
92-01109	size: 170 x 255 mm	50 pieces



**Textile filter with zz-seam, unbleached, with 4 holes**  
**REF**

pack. unit

 92-01112 size: 220 x 255 mm  
 92-02306 size: 130 x 240 mm  
 92-02313 size: 140 x 420 mm

 50 pieces  
 50 pieces  
 50 pieces

**Textile filter with zz-seam, unbleached, with 6 holes**

 rectangular filter  
 hole punching: 6

 92-01113 size: 220 x 230 mm  
 92-02310 size: 234 x 347 mm

 50 pieces  
 50 pieces

**Textile filter with zz-seam, unbleached, with holes**

rectangular filter

 92-01694 size: 245 x 540 mm, hole punching: 10  
 92-01175 size: 235 x 530 mm, hole punching: 12

 50 pieces  
 50 pieces

**Textile filter with zz-seam, unbleached, with holes**

 round filter  
 hole punching: central Ø 10 mm

 92-01692 diameter: 180 mm  
 92-01173 diameter: 195 mm

 50 pieces  
 50 pieces

**Textile filter with zz-seam, unbleached, with holes**

REF		pack. unit
	round filter	
92-01691	diameter: 120 mm, hole punching: 2	50 pieces
92-01070	diameter: 130 mm, hole punching: 3	50 pieces



**Dispenser for filters, made of stainless steel**

92-20437	incl. mounting material for wall fastening size: 195 x 195 x 100 mm	1 piece
----------	--	---------



**Protective strips**

92-09006	To protect the surface of coated (anodised) container lids when the containers are stacked up and to improve their lubricity while stacking. With predetermined breaking point. size: 10 x 205 mm without indicator	4 pieces
----------	--	----------





**System basket in DIN-StU-standard without lid, material 1.4301, chromium-nickel steel**

REF pack. unit

electrolytically polished, burr-free, with double peripheral safety frame (DBGM).

with drop-type handles  
stackable

92-08809	System basket XL-560/50 size: 560 x 250 x 50 mm mesh size: 4.0 x 4.0 mm	1 piece
92-08810	System basket XL-560/70 size: 560 x 250 x 70 mm mesh size: 5.0 x 5.0 mm	1 piece
92-08416	System basket 1/1 size: 480 x 250 x 50 mm mesh size: 4.0 x 4.0 mm	1 piece
92-08417	System basket 1/1 size: 480 x 250 x 70 mm mesh size: 5.0 x 5.0 mm	1 piece
92-08808	System basket 1/1 size: 480 x 250 x 100 mm mesh size: 5.0 x 5.0 mm	1 piece
92-08415	System basket 1/2 size: 240 x 250 x 50 mm mesh size: 4.0 x 4.0 mm	1 piece



**Mesh baskets without lid, made of stainless steel**

with drop-type handles  
mesh size: 6.0 x 6.0 mm

92-08909	size: 250 x 240 x 50 mm	1 piece
92-08908	size: 400 x 250 x 70 mm	1 piece



**Mesh baskets without lid, made of stainless steel**

92-08951	with drop-type handles size: 280 x 160 x 30 mm mesh size: 5.0 x 5.0 mm	1 piece
----------	--	---------



**Perforated plate mesh tray**

	REF		pack. unit
		Material 1.4301, electrolytically polished, burr-free.	
		perforated plate side walls mesh size of base: 4 x 4 x 1 mm with drop-type handles without lid	
	92-08474	size: 480 x 250 x 65 mm dish tray 1/1-60/50 with base stacking frame	1 piece
	92-08432	size: 480 x 250 x 105 mm dish tray 1/1-100/105 with base stacking frame	1 piece
	92-08478	size: 240 x 250 x 65 mm dish tray 1/2-60/65 with base stacking frame	1 piece
	92-08473	size: 480 x 250 x 60 mm dish tray 1/1-60 without stacking frame	1 piece
	92-08475	size: 240 x 250 x 60 mm dish tray 1/1-100 without stacking frame	1 piece
	92-08476	size: 240 x 250 x 60 mm dish tray 1/2-60 without stacking frame	1 piece

**Perforated plate mesh tray**



92-08975	perforated plate side walls mesh size of base: 6 x 6 mm size: 120 x 250 x 60 mm	1 piece
----------	---	---------



**Perforated plate mesh tray**

REF		pack. unit	
	perforated plate side walls mesh size of base: 3 x 3 mm with lid		
92-08103	size: 240 x 250 x 40 mm	1 piece	
92-08104	size: 480 x 250 x 40 mm	1 piece	

**Perforated plate mesh tray**

	perforated plate side walls mesh size of base: 6 x 6 mm		
92-08960	size: 120 x 250 x 64 mm	1 piece	
92-08961	size: 240 x 250 x 64 mm	1 piece	
92-08962	size: 480 x 250 x 64 mm	1 piece	
92-08963	size: 240 x 250 x 100 mm	1 piece	
92-08964	size: 480 x 250 x 100 mm	1 piece	

**Perforated plate mesh tray**

	perforated plate side walls mesh size of base: 6 x 6 mm		
92-08993	size: 120 x 300 x 64 mm	1 piece	
92-08994	size: 240 x 300 x 64 mm	1 piece	
92-08995	size: 480 x 300 x 64 mm	1 piece	

**Perforated plate mesh tray**

	perforated plate side walls mesh size of base: 6 x 6 mm		
92-08996	size: 115 x 320 x 64 mm	1 piece	
92-08997	size: 230 x 320 x 64 mm	1 piece	
92-08998	size: 460 x 320 x 64 mm	1 piece	

**Perforated plate mesh tray**

REF

pack. unit

NEW



perforated plate side walls  
 mesh size of base: 6 x 6 mm  
 RFID-chip: integrated (ISO-15693), green

92-08972 size: 480 x 250 x 64 mm  
 92-08973 size: 240 x 250 x 64 mm

1 piece  
 1 piece

**Lid for perforated plate mesh tray, with silicone corners**

NEW

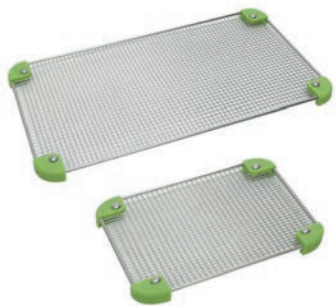

for easy closing of the tray

silicone corners: green

92-08970 size: 480 x 250 x 11 mm  
 for REF 92-08962 and 92-08964

92-08971 size: 240 x 250 x 11 mm  
 for REF 92-08961 and 92-08963

1 piece  
 1 piece

**Silicone mesh inserts - "honeycomb structure" for perforated plate mesh tray**

NEW

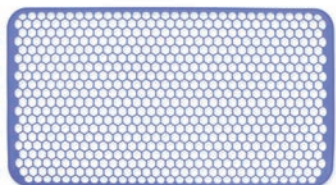

dark blue  
 flexible  
 heat resistant: up to +230 °C  
 washable in washer-disinfector



92-08601 size: 480 x 250 mm  
 92-08602 size: 238 x 248 mm

1 piece  
 1 piece





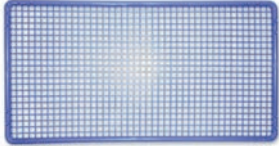

**Silicone mesh cover 1/1 for system tray**

REF		pack. unit	
	blue heat resistant: up to 134 °C washable in washer-disinfector		
ER856.000B	frame: rigid (inner frame made of stainless steel) size (external): 445 x 230 mm size (internal): 425 x 210 mm	1 piece	
ER856.100B	frame: flexible size (external): 430 x 230 mm size (internal): 415 x 210 mm	1 piece	

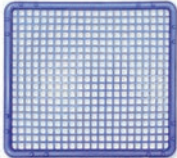
**Silicone mesh cover 1/2 for system tray**

	blue heat resistant: up to 134 °C washable in washer-disinfector size (external): 235 x 210 mm size (internal): 215 x 190 mm		
ER855.000B	frame: rigid (inner frame made of stainless steel)	1 piece	
ER856.100B	frame: flexible	1 piece	

**Mesh cover 1/1 made of stainless steel for system tray**

92-08847	heat resistant washable in washer-disinfector frame: rigid size (external): 445 x 230 mm	1 piece	
----------	---	---------	---

**System sieves in DIN-StU-standard**

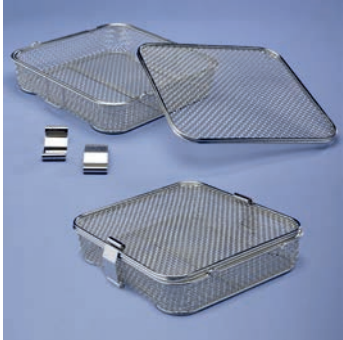
	material: chromium-nickel steel		
92-08830	1/1 size: 480 x 240 x 50 mm mesh size: 4.0 x 4.0 x 1.0 mm	1 piece	
92-08831	1/1 size: 480 x 240 x 70 mm mesh size: 5.0 x 5.0 x 1.0 mm	1 piece	
92-08832	1/2 size: 240 x 240 x 50 mm mesh size: 4.0 x 4.0 x 1.0 mm	1 piece	

**System sieves in DIN-StU-standard**

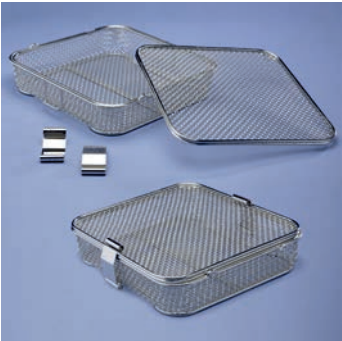
	REF		pack. unit
	92-08833	1/2 size: 240 x 240 x 70 mm mesh size: 5.0 x 5.0 x 1.0 mm	1 piece

**Lids for system sieves in DIN-StU-standard**

		Material 1.4301, electrolytically polished, burr-free, with double peripheral safety frame (DBGM).	
		material: chromium-nickel steel	
	92-08834	suitable for: REF 92-08830 size: 482 x 241 x 8 mm 2 fixed clips mesh size: 4.0 x 4.0 mm	1 piece
	92-08835	suitable for: REF 92-08830 size: 482 x 241 x 8 mm 2 removable clips mesh size: 4.0 x 4.0 mm	1 piece
	92-08836	suitable for: REF 92-08831 size: 482 x 241 x 8 mm 2 fixed clips mesh size: 4.0 x 4.0 mm	1 piece
	92-08837	suitable for: REF 92-08831 size: 482 x 241 x 8 mm 2 removable clips mesh size: 4.0 x 4.0 mm	1 piece
	92-08838	suitable for: REF 92-08832 size: 242 x 241 x 8 mm 2 fixed clips mesh size: 4.0 x 4.0 mm	1 piece
	92-08839	suitable for: REF 92-08832 size: 242 x 241 x 8 mm 2 removable clips mesh size: 4.0 x 4.0 mm	1 piece
	92-08841	suitable for: REF 92-08833 size: 242 x 241 x 8 mm 2 removable clips mesh size: 4.0 x 4.0 mm	1 piece

**Lids for system sieves in DIN-StU-standard**

REF		pack. unit
92-08840	suitable for: REF 92-08833 size: 242 x 241 x 8 mm 2 fixed clips mesh size: 4.0 x 4.0 mm	1 piece
92-08947	suitable for: REF 92-08405 size: 236 x 121 x 8 mm 2 removable clips mesh size: 2.5 x 2.5 x 0.7 mm	1 piece

**System small parts sieve trays**

Material 1.4301, electrolytically polished, burr-free, with double peripheral safety frame (DBGM).

material: chromium-nickel steel  
with clips

92-08463	SET 1/4 with lid and clips size: 236 x 121 x 28 mm mesh size: 1.0 x 1.0 x 0.5 mm	1 set
92-08464	SET 1/4 with lid and clips size: 236 x 121 x 28 mm mesh size: 2.5 x 2.5 x 0.7 mm	1 set
92-08465	1/4 without lid and clips size: 236 x 121 x 28 mm mesh size: 1.0 x 1.0 x 0.5 mm	1 piece
92-08466	1/4 without lid and clips size: 236 x 121 x 28 mm mesh size: 2.5 x 2.5 x 0.7 mm	1 piece
92-08404	SET 1/4 with lid and clips size: 236 x 121 x 46 mm mesh size: 2.5 x 2.5 x 0.7 mm	1 set
92-08405	1/4 without lid and clips size: 236 x 121 x 46 mm mesh size: 2.5 x 2.5 x 0.7 mm	1 piece
92-08454	SET 1/6 with lid and clips size: 236 x 73.5 x 28 mm mesh size: 1.0 x 1.0 x 0.5 mm	1 set



**System small parts sieve trays**

REF		pack. unit
92-08457	1/6 without lid and clips size: 236 x 73.5 x 28 mm mesh size: 1.0 x 1.0 x 0.5 mm	1 piece
92-08448	SET 1/8 with lid and clips size: 121 x 121 x 29 mm mesh size: 1.0 x 1.0 x 0.5 mm	1 set
92-08450	1/8 without lid and clips size: 121 x 121 x 29 mm mesh size: 1.0 x 1.0 x 0.5 mm	1 piece
92-08406	SET 1/8 with lid and clips size: 121 x 121 x 29 mm mesh size: 2.5 x 2.5 x 0.7 mm	1 set
92-08451	1/8 without lid and clips size: 121 x 121 x 47 mm mesh size: 2.5 x 2.5 x 0.7 mm	1 piece
92-08449	SET 1/8 with lid and clips size: 121 x 121 x 47 mm mesh size: 2.5 x 2.5 x 0.7 mm	1 set
92-08407	1/8 without lid and clips size: 121 x 121 x 29 mm mesh size: 2.5 x 2.5 x 0.7 mm	1 piece
92-08408	SET 1/16 with lid size: 121 x 73 x 29 mm mesh size: 1.0 x 1.0 x 0.5 mm	1 set
92-08409	1/16 without lid and clips size: 121 x 73 x 29 mm mesh size: 1.0 x 1.0 x 0.5 mm	1 piece
92-08442	SET 1/32 with lid and clips size: 63 x 63 x 23.4 mm mesh size: 1.0 x 1.0 x 0.5 mm	1 set







**Clamp element for system small parts sieve tray REF 08408**

REF		pack. unit	
92-08438	8 crosswires for choice clamps  size: 107 x 59 x 16 mm	1 set	

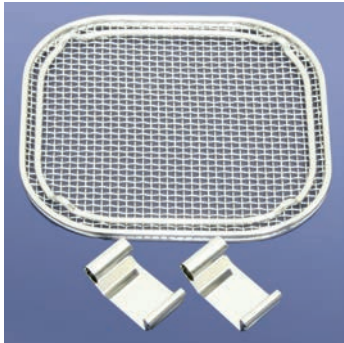
**Lids for system small parts sieve trays**

REF	material: chromium-nickel steel 2 clips		
92-08430	suitable for: REF 92-08409 size: 121 x 73 x 7 mm, mesh size: 1.0 x 1.0 x 0.5 mm	1 piece	
92-08452	suitable for: REF 92-08450 size: 121 x 121 x 7 mm mesh size: 1.0 x 1.0 x 0.5 mm	1 piece	
92-08431	suitable for: REF 92-08407 size: 121 x 121 x 7 mm mesh size: 2.5 x 2.5 x 0.7 mm	1 piece	
92-08461	suitable for: REF 92-08457 size: 236 x 73.5 x 7 mm mesh size: 1.0 x 1.0 x 0.5 mm	1 piece	
92-08467	suitable for: REF 92-08465 size: 236 x 121 x 7 mm mesh size: 1.0 x 1.0 x 0.5 mm	1 piece	
92-08468	suitable for: REF 92-08466 size: 236 x 121 x 7 mm mesh size: 2.5 x 2.5 x 0.7 mm	1 piece	

**Clips for system sieve trays**

92-08918	size: 64 x 30 x 0.5 mm, fixed clips	1 piece	
92-08919	size: 84 x 30 x 0.5 mm, removable clips	1 piece	

System sieve trays (SETS)

REF		pack. unit
92-08400	Material 1.4301, electrolytically polished, burr-free. Trays, lids and dividers with double peripheral safety frame (DBGM). material: chromium-nickel steel  SET 1/1 with lid size: 480 x 250 x 57 mm mesh size: 2.5 x 2.5 x 0.7 mm Set consisting of: <ul style="list-style-type: none"> <li>• 1 x system sieve 1/1 with clips</li> <li>• with lid and variable partition</li> <li>• 1 x lengthwise divider 1/1</li> <li>• 1 x crosswise divider 1/1</li> <li>• 1 x crosswise divider 2/3</li> <li>• 1 x crosswise divider 1/3</li> <li>• 8 x T-clip</li> </ul>	1 set
92-08401	1/1 without lid size: 480 x 250 x 50 mm mesh size: 2.5 x 2.5 x 0.7 mm	1 piece
92-08471	 1/2 size: 236 x 236 x 28 mm mesh size: 2.5 x 2.5 x 0.7 mm with lid, with clips Set consisting of: <ul style="list-style-type: none"> <li>• 1 x system sieve 1/2 with clips</li> <li>• 1 x lid</li> </ul>	1 set
92-08402	SET 1/2 with lid size: 236 x 236 x 28 mm mesh size: 1.0 x 1.0 x 0.5 mm Set consisting of: <ul style="list-style-type: none"> <li>• 1 x system sieve 1/2 with clips</li> <li>• 1 x lid</li> </ul>	1 set
92-08403	1/2 without lid size: 236 x 236 x 28 mm mesh size: 1.0 x 1.0 x 0.5 mm	1 piece
92-08472	SET 1/2 with lid size: 236 x 236 x 46 mm mesh size: 1.0 x 1.0 x 0.5 mm Set consisting of: <ul style="list-style-type: none"> <li>• 1 x system sieve 1/2H with clips</li> <li>• 1 x lid</li> </ul>	1 set



**System sieve trays (SETS)**

REF		pack. unit
92-08922	1/2 without lid size: 236 x 236 x 46 mm mesh size: 1.0 x 1.0 x 0.5 mm	1 piece
92-08469	SET 1/3 with lid size: 466 x 73.5 x 28 mm mesh size: 1.0 x 1.0 x 0.5 mm Set consisting of: <ul style="list-style-type: none"> <li>• 1 x system sieve 1/3L with clips</li> <li>• 1 x lid</li> </ul>	1 set



**System sieve - lid**

Material 1.4301, electrolytically polished, burr-free, with double peripheral safety frame (DBGM).

material: chromium-nickel steel  
2 clips

92-08445	suitable for: REF 92-08401 size: 480 x 250 x 7 mm mesh size: 2.5 x 2.5 x 0.7 mm	1 piece
92-08446	suitable for: REF 92-08403 size: 236 x 236 x 7 mm mesh size: 1.0 x 1.0 x 0.5 mm	1 piece
92-08923	suitable for: REF 92-08922 size: 236 x 236 x 7 mm mesh size: 2.5 x 2.5 x 0.7 mm	1 piece



**System sieve trays SET in DIN-StU-standard**

REF		pack. unit
	Material 1.4301, electrolytically polished, burr-free, with double peripheral safety frame (DBGM).  material: chromium-nickel steel	
92-08824	SET 1/1 SL consisting of: • 2 x system sieve tray 1/1 480 x 240 x 50 mm • 2 x clip	1 set
92-08826	SET 1/1 SL consisting of: • 2 x system sieve tray 1/1 480 x 240 x 70 mm • 2 x clip	1 set
92-08825	SET 1/1 SL consisting of:  • 1 x system sieve tray 1/1 480 x 240 x 50 mm • 1 x system sieve tray 1/1 480 x 240 x 70 mm • 2 x clip	1 set
92-08827	SET 1/1 SL consisting of: • 2 x system sieve tray 1/2 240 x 240 x 50 mm • 2 x clip	1 set
92-08829	SET 1/1 SL consisting of: • 2 x system sieve tray 1/2 240 x 240 x 70 mm • 2 x clip	1 set
92-08828	SET 1/2 SL consisting of:  • 1 x system sieve tray 1/2 240 x 240 x 50 mm • 1 x system sieve tray 1/2 240 x 240 x 70 mm • 2 clip	1 set



**Rochard sieve with lid**



92-08801	Material 1.4301, electrolytically polished, burr-free. Tray and lid with double peripheral safety frame (DBGM).  material: chromium-nickel steel size: 725 x 275 x 113 mm mesh size: 5.0 x 5.0 x 1.0 mm with lid	1 piece
----------	---	---------





**Endoscope fixture SET for REF 08801**

REF		pack. unit
92-08802	Set consisting of: <ul style="list-style-type: none"> <li>• 2 x crosswise divider 1/1</li> <li>• 2 x silicone tray "fir tree" 12-fold</li> <li>• 4 x clip</li> </ul> size: 257 x 98 mm	1 set

**Mesh baskets for lenses**

Material 1.4301, electrolytically polished, burr-free. Tray and lid with double peripheral safety frame (DBGM).

material: chromium-nickel steel  
mesh size: 2.5 x 2.5 x 0.7 mm  
with clips

92-08470	SET 1/3 with lid size: 466 x 73.5 x 47 mm Set consisting of: <ul style="list-style-type: none"> <li>• 1 x system small parts sieve tray 1/3L with clips</li> <li>• 1 x lid</li> </ul>	1 set
92-08453	SET 1/6 with lid size: 236 x 73.5 x 47 mm Set consisting of: <ul style="list-style-type: none"> <li>• 1 x system small parts sieve tray 1/6 with clips</li> <li>• 1 x lid</li> </ul>	1 set
92-08456	1/6 without lid size: 236 x 73.5 x 47 mm	1 piece
92-08455	SET 1/6 with lid size: 296 x 73.5 x 47 mm Set consisting of: <ul style="list-style-type: none"> <li>• 1 x system small parts sieve tray 1/6 XL with clips</li> <li>• 1 x lid</li> </ul>	1 set
92-08459	1/6 without lid size: 296 x 73.5 x 47 mm	1 piece



**Lids for mesh baskets for lenses**

	REF		pack. unit
	92-08460	material: chromium-nickel steel mesh size: 2.5 x 2.5 x 0.7 mm 2 clips size: 236 x 73.5 x 7 mm for REF 92-08456	1 piece
	92-08462	size: 296 x 73.5 x 7 mm for REF 92-08459	1 piece

**Storage trays for instruments, made of stainless steel**

	92-08939	silicone fixture: for two lenses size: 290 x 80 x 52 mm incl. lid	1 piece
--	----------	---	---------

**Soil sieves made of stainless steel**

		suitable for REF 92-17150, 92-17160, 92-17170, 92-17180, 92-17190, 92-17191 and 92-17192	
	92-08458	size: 245 x 175 x 90 mm mesh size: 10.0 x 10.0 mm	1 piece
	92-08803	with handle size: 245 x 175 x 90 mm mesh size: 3.0 x 3.0 mm	1 piece
	92-08956	with handle size: 270 x 192 x 90 mm mesh size: 4.2 x 4.2 mm	1 piece

**Small parts washing basket**

	92-08880	With lid, hinge and spring cap. Side walls, division bars, lid and base perforated, electrolytically polished, stainless steel 1.4301 with 65 panels 40 x 15 mm each.  mesh size: 2.5 x 2.5 mm size: 200 x 200 x 25 mm	1 piece
---	----------	---	---------



**Small parts washing basket - semi circular design**

REF pack. unit

---

92-08878 for fixture REF 92-08876, electrolytically polished, stainless steel 1.4301

1 piece

mesh size: 0.4 x 0.4 mm  
size: 76 mm Ø x 32 mm height



**Small parts washing basket - bucket design**

92-08879 for fixture REF 92-08877, electrolytically polished, stainless steel 1.4301

1 piece

mesh size: 0.4 x 0.4 mm  
size: 76 mm Ø top /  
45 mm Ø bottom x 70 mm height



**Covering basket for small parts washing baskets**

92-08874 size: 330 x 230 x 97 mm  
6-fold fixture (82 x 82 mm)  
2 recessed grips, stackable,  
electrolytically polished, stainless steel 1.4301  
(small parts washing baskets and fixtures not included).

1 piece



**Fixtures for small parts washing basket**

the lid locks in position, electrolytically polished, stainless steel 1.4301

mesh size: 0.5 x 0.5 mm (lid)  
mesh size: 0.4 x 0.4 mm (sieve)  
size: 80 x 80 x 92 mm

92-08876 semi circular design  
92-08877 bucket design

1 piece  
1 piece



**Storage trays for instruments, made of stainless steel**

REF pack. unit

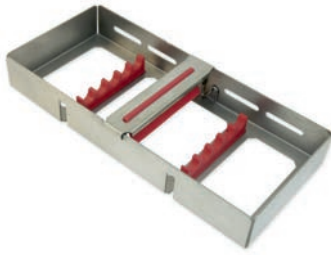

92-08940

size: 180 x 80 x 25 mm  
with silicone holder (5-fold) and fixing bracket

1 piece

**Flushing mesh basket with lid, made of stainless steel**



mesh size of base: 6 x 6 mm  
mesh size: 1.6 x 1.6 x 0.7 mm  
sheath made of perforated plate

92-08942

size: 480 x 250 x 60 mm

1 piece

92-08943

size: 240 x 250 x 60 mm

1 piece

electrolytically polished  
mesh size: 1.6 x 1.6 x 0.7 mm

92-08434

size: 80 x 80 x 40 mm

1 piece

92-08435

size: 80 x 40 x 30 mm

1 piece



**Small parts sieve trays with lid, made of stainless steel**

REF		pack. unit
	mesh size: 1.0 x 1.0 mm	
92-08910	size: 40 x 40 x 20 mm	1 piece
92-08935	size: 80 x 40 x 20 mm	1 piece
92-08911	size: 80 x 80 x 40 mm	1 piece
92-08931	size: 150 x 110 x 20 mm	1 piece
92-08912	size: 160 x 40 x 20 mm	1 piece
92-08936	size: 200 x 40 x 40 mm	1 piece
92-08957	size: 230 x 150 x 50 mm	1 piece



**Mesh baskets with lid, made of stainless steel**

	mesh size: 3.0 x 3.0 mm	
92-08896	size: 40 x 40 x 20 mm	1 piece
92-08897	size: 80 x 40 x 20 mm	1 piece
92-08900	size: 80 x 40 x 40 mm	1 piece
92-08901	size: 80 x 80 x 40 mm	1 piece
92-08902	size: 90 x 90 x 50 mm	1 piece
92-08903	size: 150 x 110 x 20 mm	1 piece
92-08898	size: 160 x 40 x 20 mm	1 piece
92-08904	size: 180 x 130 x 20 mm	1 piece
92-08899	size: 200 x 40 x 40 mm	1 piece
92-08948	size: 200 x 60 x 40 mm	1 piece
92-08905	size: 210 x 170 x 20 mm	1 piece
92-08906	size: 250 x 200 x 20 mm	1 piece
92-08907	size: 300 x 180 x 20 mm	1 piece



**Mesh baskets with lid, made of stainless steel**

92-08950	size: 300 x 150 x 70 mm mesh size: 4.0 x 4.0 mm	1 piece
----------	--	---------



**Silicone fixture for 5 instruments**

92-08949	self-retaining  light blue coloured size: 125 x 25 x 4 mm silicone fixture: 5-fold	6 pieces
----------	--	----------

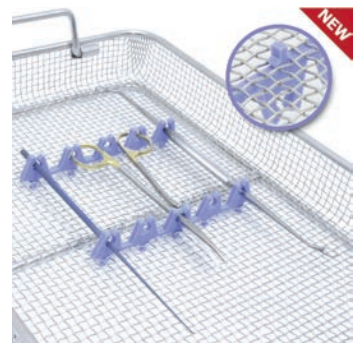

**Fixture sets for lenses**

REF		pack. unit	
	REF 92-08487, 92-08913, 92-08492 suitable for small parts sieve tray REF 92-08470, 92-08453, 92-08456, 92-08455, 92-08459		
92-08487	for one lens Ø 5 mm size: 60 x 38 mm Set consisting of: <ul style="list-style-type: none"> <li>• 2 x crosswise divider</li> <li>• 2 x silicone tray</li> <li>• and 4 x clip</li> </ul>	1 set	
	92-08913	for two lenses Ø 2 mm size: 60 x 38 mm Set consisting of: <ul style="list-style-type: none"> <li>• 2 x crosswise divider</li> <li>• 2 x silicone tray</li> <li>• and 4 x clip</li> </ul>	1 set
	92-08492	for two lenses Ø 5 mm size: 60 x 38 mm Set consisting of: <ul style="list-style-type: none"> <li>• 2 x crosswise divider</li> <li>• 2 x silicone tray</li> <li>• and 4 x clip</li> </ul>	1 set
92-08494	for three lenses Ø 10 mm size: 152 x 38 mm Set consisting of: <ul style="list-style-type: none"> <li>• 2 x crosswise divider</li> <li>• 2 x silicone tray 3-fold</li> <li>• and 4 x clip</li> </ul>	1 set	
92-08842	for three lenses Ø 5 mm size: 152 x 38 mm Set consisting of: <ul style="list-style-type: none"> <li>• 2 x crosswise divider</li> <li>• 2 x silicone tray 3-fold</li> <li>• and 4 x clip</li> </ul>	1 set	



**Fixture sets for lenses**

REF		pack. unit
92-08843	for five lenses Ø 10 mm size: 152 x 38 mm Set consisting of: • 2 x crosswise divider • 2 x silicone tray 5-fold • and 4 x clip	1 set
92-08844	for five lenses Ø 5 mm size: 152 x 38 mm Set consisting of: • 2 x crosswise divider • 2 x silicone tray 5-fold • and 4 x clip	1 set



**Retainers for silicone fixture, screwable**

92-08848	length: 55 mm / 2 pins / distance: 30 mm	1 piece
92-08849	length: 65 mm / 2 pins / distance: 45 mm	1 piece
92-08850	length: 90 mm / 3 pins / distance: 30 mm	1 piece
92-08851	length: 110 mm / 3 pins / distance: 45 mm	1 piece
92-08852	length: 140 mm / 3 pins / distance: 60 mm	1 piece
92-08853	length: 200 mm / 2 pins / distance: 60 mm	1 piece



**Silicone fixtures**

92-08859	for one lens Ø 5 mm size: 44 x 30 x 5 mm suitable for retainer: REF 92-08848	1 piece
92-08855	for one lens Ø 10 mm size: 44 x 30 x 5 mm suitable for retainer: REF 92-08848	1 piece
92-08860	for two lenses Ø 2 mm size: 46 x 33 x 5 mm suitable for retainer: REF 92-08848	1 piece
92-08857	for two lenses Ø 5 mm size: 46 x 33 x 5 mm suitable for retainer: REF 92-08848	1 piece
92-08856	for two lenses Ø 5 mm and Ø 10 mm size: 46 x 33 x 5 mm suitable for retainer: REF 92-08848	1 piece
92-08863	for five lenses Ø 10 mm size: 137 x 35 x 5 mm suitable for retainer: REF 92-08852	1 piece



### Silicone fixtures

	REF		pack. unit
	92-08865	slotted (17-fold) size: 137 x 25 x 5 mm suitable for retainer: REF 92-08852	1 piece
	92-08872	slotted (23-fold) size: 89 x 25 x 5 mm suitable for retainer: REF 92-08850	1 piece
	92-08870	slotted (37-fold) size: 230 x 25 x 5 mm suitable for retainer: REF 92-08853	1 piece
	92-08871	slotted (51-fold) size: 206 x 25 x 5 mm suitable for retainer: REF 92-08853	1 piece
	92-08868	"fir tree" (5-fold) ø 8 - 14 mm size: 94 x 25 x 5 mm suitable for retainer: REF 92-08850	1 piece
	92-08866	"fir tree" (12-fold) ø 8 - 14.5 mm size: 229 x 35 x 5 mm suitable for retainer: REF 92-08853	1 piece
	92-08867	"fir tree" (18-fold) ø 1 - 7.5 mm size: 206 x 25 x 5 mm suitable for retainer: REF 92-08853	1 piece

### Fixture SET MIC



92-08493	Set consisting of: <ul style="list-style-type: none"> <li>• 2 x crosswise divider</li> <li>• 1 x silicone tray "fir tree"</li> <li>• 1 x silicone tray "slotted"</li> <li>• 4 x clip</li> </ul>	1 set
	size: 109 x 38 mm suitable for: system small parts sieve trays REF 92-08404, 92-08405	



**Cross- / lengthwise divider for system small parts sieve trays incl. 2 clips**

REF pack. unit

REF		pack. unit
	for individual division	
92-08436	1/1, size: 465 x 43 mm mesh size: 2.5 x 2.5 x 0.7 mm	1 piece
92-08480	1/1, size: 278 x 241 mm mesh size: 2.5 x 2.5 mm suitable for: REF 92-08419	1 piece
92-08483	1/1, size: 232 x 43 mm mesh size: 2.5 x 2.5 x 0.7 mm	1 piece
92-08412	1/1, size: 224 x 42 mm mesh size: 2.5 x 2.5 x 0.7 mm	1 piece
92-08411	1/1, size: 224 x 24 mm mesh size: 2.5 x 2.5 x 0.7 mm	1 piece
92-08410	1/1, size: 224 x 24 mm mesh size: 1.0 x 1.0 x 0.5 mm	1 piece
92-08414	1/1, size: 109 x 24 mm mesh size: 2.5 x 2.5 x 0.7 mm	1 piece
92-08413	1/1, size: 109 x 24 mm mesh size: 1.0 x 1.0 x 0.5 mm	1 piece
92-08481	1/1, size: 61.5 x 24 mm mesh size: 1.0 x 1.0 x 0.5 mm	1 piece
92-08479	1/2, size: 278 x 118 mm mesh size: 1.0 x 1.0 mm suitable for: REF 08418	1 piece
92-08482	2/3, size: 300 x 43 mm mesh size: 2.5 x 2.5 x 1.0 mm	1 piece
92-08484	2/3, size: 152 x 43 mm mesh size: 2.5 x 2.5 x 1.0 mm	1 piece
92-08485	2/3, size: 152 x 43 mm mesh size: 1.0 x 1.0 x 0.7 mm	1 piece
92-08437	1/3, size: 71 x 43 mm mesh size: 2.5 x 2.5 x 0.7 mm	1 piece
92-08486	1/3, size: 71 x 43 mm mesh size: 1.0 x 1.0 x 0.5 mm	1 piece

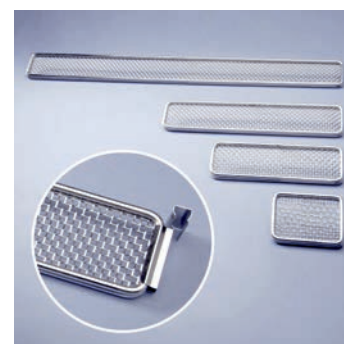

### Screw rack

	REF		pack. unit
	92-08495	Material 1.4301, electrolytically polished, burr-free. For screws with length of 40 mm, gauge-plate.	1 piece
		material: chromium-nickel steel size: 215 x 100 x 45 mm	

### Lid for Screw rack REF 08495

	92-08496	material: chromium-nickel steel size: 222 x 116 x 7 mm	1 piece
---	----------	---	---------

### Screw tray with 8 panels

	92-08920	for screws up to 90 mm, with engraved ruler	1 piece
		material: chromium-nickel steel mesh size: 1.0 x 1.0 x 0.5 mm size: 184 x 135 x 25 mm	

### Lid for screw tray REF 08920

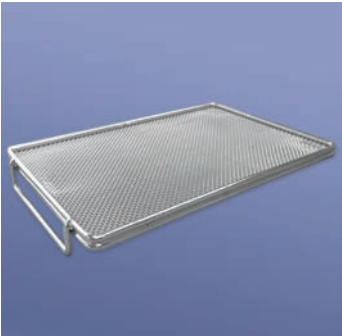
	92-08921	material: chromium-nickel steel mesh size: 1.0 x 1.0 x 0.5 mm size: 165 x 135 x 7 mm	1 piece
---	----------	--	---------



**Screw tray with 5 panels lengthwise**

REF pack. unit

---

92-08937 for screws up to 140 mm,  
with engraved diameter gauge

1 piece

material: chromium-nickel steel  
mesh size: 1.0 x 1.0 x 0.5 mm  
size: 165 x 135 x 25 mm



**Lid for screw tray REF 92-08937**

---

92-08938 material: chromium-nickel steel  
mesh size: 1.0 x 1.0 x 0.5 mm  
size: 165 x 135 x 6 mm

1 piece



**Panel storage set**

---

92-08944 Set consisting of:  
• 1 x panel storage  
• 1 x lid for panel storage  
• 26 x small bolts  
• including nuts and washers  
  
size: 190 x 115 mm

1 piece

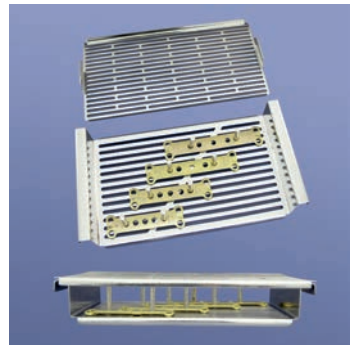

**Raised inlay tray 1/1-50**

---

92-08433 With ground-distance and hand-grip for  
extraction. Material 1.4301, electrolytically  
polished, burr-free with double peripheral safety  
frame (DBGM).

1 piece

material: chromium-nickel steel  
mesh size: 4.0 x 4.0 mm  
size: 420 x 230 x 35 mm

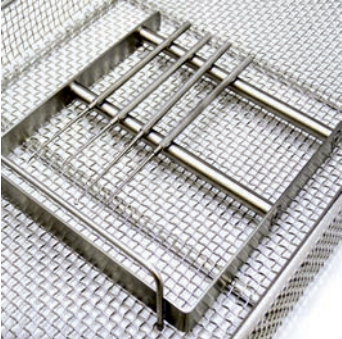

**Magnoline® magnetic rack for micro instruments**

REF		pack. unit
	Attention: Instruments can get magnetized!!	
	heat resistant material: stainless steel washable in washer-disinfector double-sided usable	
92-20400	size: 150 x 170 mm	1 piece
92-20401	size: 80 x 170 mm	1 piece

**Instrument clips made of stainless steel**

	Ring-instruments can be bundled through the clips. Thereby, instrument-groups can be individually bundled and orderly grouped inside the mesh-basket.		
	92-20403	small (75 mm)	1 piece
	92-20404	medium (100 mm)	1 piece
	92-20405	large (125 mm)	1 piece

**Band clamps made of stainless steel with silicone covering**

	The belt-clips keep joints and jaw-parts open, e.g. of bone tongs.		
	92-20411	yellow inner size: 50 mm	1 piece
	92-20408	blue inner size: 60 mm	1 piece
	92-20406	orange/red inner size: 70 mm	1 piece
	92-20412	green inner size: 80 mm	1 piece
	92-20460	white inner size: 40 mm	1 piece

**Spreader made of rustproof stainless steel for instruments with ring handle**

	92-20407	With this spreader non-dismantable instruments with ring handle can be cleaned more efficiently in the washer-disinfector. The jaws remain open during the cleaning process, thus assuring thorough cleaning.	1 piece
---	----------	---	---------



**Spreaders made of rustproof stainless steel, durable material**  
REF

pack. unit

With this spreader non-dismantable instruments with ring handle can be cleaned more efficiently in the washer-disinfector. The jaws remain open during the cleaning process, thus assuring thorough cleaning.

92-20413	hole diameter: 4.8 mm for microclips	1 piece
92-20409	hole diameter: 6 mm Dieffenbach vessel	5 pieces
92-20429	hole diameter: 8.4 mm Dieffenbach vessel	5 pieces
92-20410	hole diameter: 10 mm Dieffenbach vessel	5 pieces
92-20430	hole diameter: 14 mm oval Dieffenbach vessel	5 pieces



**Spreaders made of plastic for single use**

With this spreader non-dismantable instruments with ring handle can be cleaned more efficiently in the washer-disinfector. The jaws remain open during the cleaning process, thus assuring thorough cleaning.

heat resistant: up to 134 °C

for microclips  
hole diameter: 4.8 mm

92-20414	red	50 pieces
92-20415	green	50 pieces
92-20416	blue	50 pieces
92-20417	yellow	50 pieces
92-20418	white	50 pieces

for Dieffenbach vessels  
hole diameter: 6 mm

92-20419	red	50 pieces
92-20420	green	50 pieces
92-20421	blue	50 pieces
92-20422	yellow	50 pieces
92-20423	white	50 pieces

for Dieffenbach vessels  
hole diameter: 10 mm

92-20424	red	50 pieces
92-20425	green	50 pieces
92-20426	blue	50 pieces
92-20427	yellow	50 pieces
92-20428	white	50 pieces



**Silicone Cord with two stainless steel spider hooks**

pack. unit



92-08516  
92-08556

yellow  
heat resistant: up to 134 °C  
washable  
length: 65 cm  
length: 40 cm

1 piece  
1 piece

**Clamping fixture for silicone cord**

92-08517

yellow  
heat resistant: up to 134 °C  
washable

1 piece



**Rigid card corner - size: 100 x 100 x 50 mm**



92-42007

heat resistant: up to 134 °C  
material: special carton, 270 g/m<sup>2</sup>

600 pieces



**Silicone corners**

REF		pack. unit
	permanent fixation by the use of silicone stopper REF 92-09097 possible	
	size: 76 x 54 x 33 mm purple heat resistant: up to 134 °C	
92-50062	silicone corner	4 pieces
92-50063	silicone corner	100 pieces
92-50064	Silicone corner set consisting of: <ul style="list-style-type: none"> <li>• 100 x silicone corner</li> <li>• 100 x stopper made of silicone (92-09097)</li> </ul>	1 set



**Sieve inlay**

	folded material: 100 % cellulose	
92-1136011	size: 33 x 30 cm, 60 g/m <sup>2</sup>	1200 pieces
92-1137011	size: 33 x 55 cm, 80 g/m <sup>2</sup>	500 pieces



**Inner Pack, for single use**

	disposable absorption pack, reducing wetness in trays and containers after the steam sterilization, 10 x 2 pcs.	
92-26220	size S (50 mm)	20 pieces
92-26221	size M (90 mm)	20 pieces

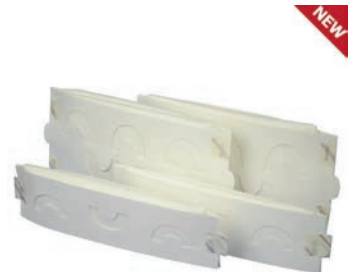

**Washing sleeve made of stainless steel for fine instruments**

	incl. 2 silicone caps, 1 ring holder and 1 tag	
	external diameter: 19 mm internal diameter: 17 mm	
92-07433	length: 55 mm	1 piece
92-07434	length: 110 mm	1 piece
92-07435	length: 165 mm	1 piece
92-07436	length: 220 mm	1 piece
92-07437	length: 275 mm	1 piece
92-07438	length: 330 mm	1 piece
92-07439	length: 385 mm	1 piece
92-07440	length: 440 mm	1 piece
92-07441	length: 495 mm	1 piece



**Washing sleeve made of stainless steel for fine instruments**

REF		pack. unit
92-07442	length: 550 mm	1 piece
92-07443	length: 605 mm	1 piece
92-07444	length: 660 mm	1 piece
92-07445	length: 715 mm	1 piece
92-07446	length: 770 mm	1 piece
92-07447	length: 825 mm	1 piece
92-07448	length: 880 mm	1 piece



**Silicone caps - height 7 mm - Ø 19 mm**

92-07451	suitable for REF 92-07433 - 92-07448	10 pieces
	transparent diameter: 19 mm height: 7 mm	



**Mesh sleeve made of stainless steel for wires**

	diameter: 22 mm mesh size: 0.8 x 0.8 mm	
92-07430	length: 170 mm	1 piece
92-07431	length: 200 mm	1 piece
92-07461	length: 330 mm	1 piece
92-07464	Lid for mesh sleeve	1 piece



**Manifolds with 6 Luer-Lock adapters**

	With 6 Luer-Lock adapters (Luer-Lock, male), 6 plugs are supplied to permit flushing of single adapters, both covers unscrewable for cleaning.	
92-25000	adapter distance: 17 mm	1 piece
92-25001	adapter distance: 27 mm	1 piece





**Stainless steel fine filter incl. silicone o-rings**
**REF**

pack. unit

92-25025      accessory for manifolds REF 92-25000 and 92-25001

10 pieces



**Adapters, tube connectors, plugs, Luer Lock female Record male**

92-25002

1 piece

**Adapter - 2 x Luer Lock female with thread**

92-25003

1 piece

**Adapter - 2 x Luer Lock male with thread**

92-25004

1 piece



**Adapter - 2 x Luer Lock male**

REF

pack. unit

92-25005

1 piece



**Adapter Luer Lock male - Luer Lock female**

92-25006

1 piece



**Tube connector - knurled - Luer Lock male**

92-25013

hose end: Ø 6 mm

1 piece



**Tube connectors - Luer Lock male**

92-25014

hose end: Ø 4 mm

1 piece

92-25015

hose end: Ø 5 mm

1 piece

92-25016

hose end: Ø 6 mm

1 piece

92-25017

hose end: Ø 8 mm

1 piece





**Tube connector - knurled - Luer Lock male**

REF		pack. unit
92-25026	with rotatable Luer-Lock hose end: Ø 6 mm	1 piece



**Tube connectors - Luer Lock female**

92-25019	hose end: Ø 5 mm	1 piece
92-25020	hose end: Ø 6 mm	1 piece
92-25021	hose end: Ø 8 mm	1 piece



**Plug - Luer Lock male**

92-25007	thread: M5 x 6 mm	1 piece
92-25008	thread: M6 x 10 mm	1 piece
92-25009	thread: M8 x 10 mm	1 piece



**Tube Connectors - Luer Lock female**

92-25010	thread: M5 x 6 mm	1 piece
92-25011	thread: M6 x 10 mm	1 piece
92-25012	thread: M8 x 10 mm	1 piece



**Plug - Luer Lock male**

REF	pack. unit
92-25022	1 piece



**Plug - Luer Lock female**

92-25023	1 piece
----------	---------



**Y-hose connector made of PP**



heat resistant: up to 134 °C  
material: polypropylene (PP)

92-25100	4 mm for diameter: from 3 - 5 mm	10 pieces
92-25101	6 mm for diameter: from 5 - 7 mm	10 pieces
92-25102	8 mm for diameter: from 7 - 9 mm	10 pieces

**Sterilization trays with lid made of plastic to protect instruments**



heat resistant: up to 134 °C

92-08422	external measurements: 150 x 65 x 26 mm internal measurements: 140 x 55 x 17 mm	1 piece
92-08424	external measurements: 230 x 175 x 42 mm internal measurements: 200 x 135 x 32 mm hinge between lid and tray	1 piece
92-08425	external measurements: 300 x 200 x 50 mm internal measurements: 270 x 173 x 40 mm hinge between lid and tray	1 piece



**Sterilization trays with lid made of plastic, to protect instruments, with silicone fixtures**

REF		pack. unit
	heat resistant: up to 134 °C size: 185 x 50 x 20 mm	
92-08883	silicone fixture: Ø 0.8 mm (1-fold)	1 piece
92-08884	silicone fixture: Ø 0.8 mm (2-fold)	1 piece



**Sterilization trays with lid made of plastic and silicone nub mat, to protect instruments**

	heat resistant: up to 134 °C	
92-08885	size: 185 x 50 x 20 mm	1 piece
92-08886	size: 150 x 60 x 20 mm	1 piece
92-08890	size: 190 x 100 x 20 mm	1 piece
92-08892	size: 185 x 75 x 20 mm	1 piece



**Sterilization trays with lid made of plastic and silicone nub mat, to protect instruments**

	with lid, clips and silicone nub mat	
	heat resistant: up to 134 °C	
92-08887	size: 270 x 160 x 15 mm with hinge and silicone nub mat	1 piece
92-08888	size: 270 x 160 x 35 mm with hinge and silicone nub mat	1 piece

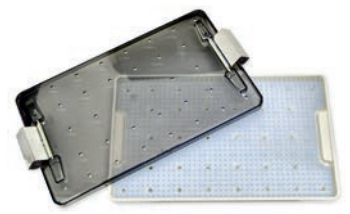

**Instrument trays made of stainless steel**

REF		pack. unit
92-08488	size: 213 x 113 x 10 mm	1 piece
92-08489	size: 235 x 165 x 10 mm	1 piece
92-08490	size: 288 x 163 x 10 mm	1 piece



**Instrument trays made of synthetic material**



	heat resistant: up to 134 °C washable in washer-disinfector size: 195 x 135 x 23 mm	
92-09832	red	12 pieces
92-09833	yellow	12 pieces
92-09834	green	12 pieces
92-09835	blue	12 pieces

**System basket in DIN-StU-standard**

Material 1.4301, electrolytically polished, burr-free, with double peripheral safety frame (DBGM).

material: chromium-nickel steel  
mesh size: bottom 24 x 24 mm  
mesh size walls: 24 x 70 mm



92-08811	1/1, with handle opening size: 295 x 580 x 150 mm	1 piece
92-08812	1/1, with handle opening size: 295 x 580 x 204 mm	1 piece
92-08813	1/1, with handle opening size: 295 x 580 x 250 mm	1 piece
92-08814	1/1, with handle opening and transport fixation size: 295 x 580 x 150 mm	1 piece
92-08815	1/1, with handle opening and transport fixation size: 295 x 580 x 204 mm	1 piece
92-08816	1/1, with handle opening and transport fixation size: 295 x 580 x 250 mm	1 piece
92-08817	1/2, with handle opening size: 295 x 300 x 150 mm	1 piece



**System basket in DIN-StU-standard**

REF		pack. unit
92-08818	1/2, with handle opening size: 295 x 300 x 204 mm	1 piece
92-08819	1/2, with handle opening size: 295 x 300 x 250 mm	1 piece
92-08820	1/2, with handle opening and transport fixation size: 295 x 300 x 150 mm	1 piece
92-08821	1/2, with handle opening and transport fixation size: 295 x 300 x 204 mm	1 piece
92-08822	1/2, with handle opening and transport fixation size: 295 x 300 x 250 mm	1 piece



**Fixing SET**

92-08823	For system basket with height 150 mm. Material 1.4301, electrolytically polished, burr-free.  material: chromium-nickel steel size: 150 x 33 x 22 mm	1 piece
----------	---	---------

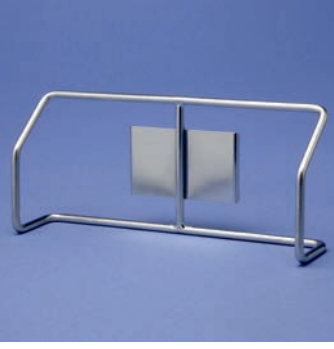

**System basket 1/2 StU**

92-08958	1/2 material: stainless steel size: 600 x 292 x 138 mm	1 piece
----------	--	---------



**Sterile goods basket DIN-StU**

Material 1.4301, electrolytically polished, burr-free, base frame designed for stacking, certified by German Association for Technical Inspection.

material: chromium-nickel steel  
with handle opening  
with base stacking frame  
mesh size: bottom 22 x 22 mm  
mesh size: walls 22 x 40 mm

92-08418	1/2, size: 575 x 280 x 135 mm	1 piece
92-08419	1/1, size: 575 x 280 x 265 mm	1 piece



**Wire container**

	REF		pack. unit
		Material 1.4301, electrolytically polished, base frame designed to facilitate stacking.	
		material: chromium-nickel steel with base stacking frame	
	92-08421	size: 230 x 150 x 125 mm	1 piece
	92-08420	size: 350 x 210 x 200 mm	1 piece

**Wire container made of stainless steel**

		The baskets are stackable and nestable.	
	92-08105	size: 600 x 400 x 100 mm	1 piece
	92-08106	size: 600 x 400 x 130 mm	1 piece
	92-08107	size: 600 x 400 x 200 mm	1 piece
	92-08108	size: 400 x 300 x 100 mm	1 piece
	92-08109	size: 600 x 300 x 50 mm	1 piece

**Mesh inserts made of silicone for wire containers**

		grey heat resistant flexible washable in washer-disinfector	
	92-08110	size: 600 x 324 mm, thickness: 6 mm	1 piece
	92-08974	size: 540 x 280 x 3 mm, thickness: 3 mm	1 piece

**Mesh basket labels for marking mesh baskets, re-usable**

		heat resistant: up to 134 °C material: plastic P-touch fit	
	92-01421	size: 90 x 50 mm with mounting holes	150 pieces
	92-01422	size: 90 x 33 mm with mounting holes	200 pieces





**PP-Mesh basket labels for marking mesh baskets, durable material, made of synthetic material , 90 x 33 mm**  
REF pack. unit

heat resistant: up to 134 °C  
material: polypropylene (PP)  
laser labeling: technically not feasible  
P-touch fit: no

92-01423	red	100 pieces
92-01424	dark green	100 pieces
92-01996	light green	100 pieces
92-01425	dark blue	100 pieces
92-01997	light blue	100 pieces
92-01426	yellow	100 pieces
92-01427	black	100 pieces
92-01428	white	100 pieces
92-01429	brown	100 pieces
92-01430	orange	100 pieces
92-01431	natural colour	100 pieces



**PP-Mesh basket labels for marking mesh baskets, durable material, made of synthetic material , 90 x 50 mm**

heat resistant: up to 134 °C  
material: polypropylene (PP)  
laser labeling: technically not feasible  
P-touch fit: no  
durable material

92-01432	red	100 pieces
92-01433	dark green	100 pieces
92-01998	light green	100 pieces
92-01434	dark blue	100 pieces
92-01999	light blue	100 pieces
92-01435	yellow	100 pieces
92-01436	black	100 pieces
92-01437	white	100 pieces
92-01438	brown	100 pieces
92-01439	orange	100 pieces
92-01440	natural colour	100 pieces











**PTL-Mesh basket labels for marking mesh baskets, durable material, made of synthetic material , 90 x 33 mm**

heat resistant: up to 134 °C  
P-touch fit  
laser imprint with text and barcode possible,  
green labels can only be engraved with text





92-01900	red	100 pieces
92-01972	coral red	100 pieces
92-01901	green	100 pieces
92-01962	dark blue	100 pieces
92-01902	light blue	100 pieces
92-01903	yellow	100 pieces
92-01912	black	100 pieces
92-01904	white	100 pieces
92-01905	orange	100 pieces
92-01956	brown	100 pieces
92-01976	pink	100 pieces
92-01977	purple	100 pieces





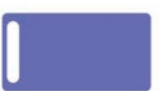

**PTL-Mesh basket labels for marking mesh baskets, durable material, made of synthetic material, 90 x 50 mm**  
REF pack. unit

		heat resistant: up to 134 °C		
		P-touch fit		
		laser imprint with text and barcode possible, green labels can only be engraved with text		
				
			01906	red 100 pieces
			01973	coral red 100 pieces
			01907	green 100 pieces
			01963	dark blue 100 pieces
			01908	light blue 100 pieces
			01909	yellow 100 pieces
			01994	black 100 pieces
			01910	white 100 pieces
			01911	orange 100 pieces
			01957	brown 100 pieces
			01978	pink 100 pieces
			01979	purple 100 pieces

**PTL-Mesh basket labels for marking mesh baskets, durable material, made of synthetic material, 40 x 20 mm**

		heat resistant: up to 134 °C		
		size: 40 x 20 mm, with hole (9 x 4 mm)		
		P-touch fit		
		laser imprint with text and barcode possible, green labels can only be engraved with text		
				
				
				
		02227	white	100 pieces
		02228	red	100 pieces
		02229	green	100 pieces
		02230	light blue	100 pieces
		02231	dark blue	100 pieces
		02232	yellow	100 pieces

**PTL-tags, durable material, made of synthetic material, Ø 25 mm**

		heat resistant: up to 134 °C		
		size: Ø 25 mm with hole (4 x 9 mm)		
		laser labeling: only with text possible		
		P-touch fit		
				
				
				
		01591	white	100 pieces
		01593	green	100 pieces
		01594	light blue	100 pieces
		01595	dark blue	100 pieces
		01596	yellow	100 pieces

**Tie-on PTL-tags, durable material, made of synthetic material , 90 x 40 mm**

 REF pack. unit

 heat resistant: up to 134 °C  
 laser labeling: with text and barcode possible  
 P-touch fit

92-02255	light red	100 pieces
92-02253	light blue	100 pieces
92-02254	white	100 pieces

**PTL-plastic labels for marking mesh baskets also suitable for Wagner containers, durable material, 60 x 40 mm**

 heat resistant: up to 134 °C  
 suitable for: REF 92-01498, REF 92-04186 and REF 92-04189  
 P-touch fit  
 laser imprint with text and barcode possible,  
 green labels can only be engraved with text

92-01948	white	100 pieces
92-01949	red	100 pieces
92-01950	green	100 pieces
92-01969	dark blue	100 pieces
92-01951	light blue	100 pieces
92-01952	orange	100 pieces
92-01953	black	100 pieces
92-01954	yellow	100 pieces
92-01990	pink	100 pieces
92-01991	purple	100 pieces

**Mesh basket label holder, made of stainless steel, with clip durable material for PTL-plastic labels for marking mesh baskets, 60 x 40 mm**

92-01498	heat resistant suitable for: REF 92-01948 - REF 92-01991	25 pieces
----------	---	-----------



**PP-Mesh basket labels with clips for marking mesh baskets, durable material, made of synthetic material - 30 x 30 mm**

	REF		pack. unit
		heat resistant: up to 134 °C laser labeling: technically not feasible P-touch fit: no	
	92-01583	orange	25 pieces
	92-01584	red	25 pieces
	92-02234	dark blue	25 pieces
	92-01585	light blue	25 pieces
	92-01586	yellow	25 pieces
	92-01587	green	25 pieces
	92-02236	white	25 pieces
	92-02237	black	25 pieces
	92-02239	pink	25 pieces
	92-02240	purple	25 pieces
92-02241	brown	25 pieces	

**PP-Mesh basket labels with clips for marking mesh baskets, durable material, made of synthetic material - 55 x 30 mm**

		heat resistant: up to 134 °C laser labeling: technically not feasible P-touch fit: no	
	92-01578	orange	25 pieces
	92-01579	red	25 pieces
	92-02235	dark blue	25 pieces
	92-01580	light blue	25 pieces
	92-01581	yellow	25 pieces
	92-01582	green	25 pieces

**PP-Mesh basket labels with clips for marking mesh baskets, durable material, made of synthetic material - 70 x 30 mm**

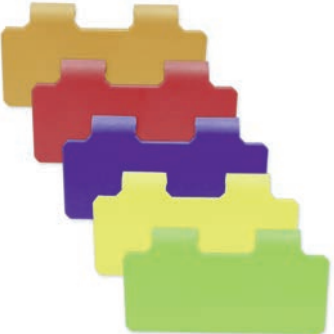
		heat resistant: up to 134 °C laser labeling: technically not feasible P-touch fit: no	
	92-02200	orange	25 pieces
	92-02201	red	25 pieces
	92-02202	blue	25 pieces
	92-02203	yellow	25 pieces
	92-02204	green	25 pieces

**PP-Mesh basket labels with clips for marking mesh baskets, durable material, made of synthetic material - 90 x 30 mm**

REF		pack. unit
	heat resistant: up to 134 °C laser labeling: technically not feasible P-touch fit: no	
92-02205	orange	25 pieces
92-02206	red	25 pieces
92-02233	dark blue	25 pieces
92-02207	light blue	25 pieces
92-02208	yellow	25 pieces
92-02209	green	25 pieces
92-02251	white	25 pieces
92-02252	black	25 pieces

**PP-Mesh basket labels with clips for marking mesh baskets, durable material, made of synthetic material - 90 x 50 mm**

	heat resistant: up to 134 °C laser labeling: technically not feasible P-touch fit: no	
92-02210	orange	25 pieces
92-02211	red	25 pieces
92-02212	blue	25 pieces
92-02213	yellow	25 pieces
92-02214	green	25 pieces
92-02247	black	25 pieces
92-02249	pink	25 pieces
92-02250	purple	25 pieces

**PTL-Mesh basket labels with clips for marking mesh baskets, durable material, made of synthetic material - 30 x 30 mm**

	heat resistant: up to 134 °C P-touch fit laser imprint with text and barcode possible, green labels can only be engraved with text	
92-01913	white	25 pieces
92-01914	red	25 pieces
92-01915	green	25 pieces
92-01964	dark blue	25 pieces
92-01916	light blue	25 pieces
92-01917	orange	25 pieces
92-01918	black	25 pieces
92-01919	ochre yellow	25 pieces
92-01563	yellow	25 pieces
92-01980	pink	25 pieces
92-01981	purple	25 pieces
92-01961	brown	25 pieces



**PTL-Mesh basket labels with clips for marking mesh baskets, durable material, made of synthetic material - 55 x 30 mm**

	REF		pack. unit
		heat resistant: up to 134 °C P-touch fit laser imprint with text and barcode possible, green labels can only be engraved with text	
	92-01920	white	25 pieces
	92-01921	red	25 pieces
	92-01922	green	25 pieces
	92-01965	dark blue	25 pieces
	92-01923	light blue	25 pieces
	92-01924	orange	25 pieces
	92-01925	black	25 pieces
	92-01926	ochre yellow	25 pieces
	92-01561	yellow	25 pieces
	92-01982	pink	25 pieces
	92-01983	purple	25 pieces
	92-01960	brown	25 pieces

**PTL-Mesh basket labels with clips for marking mesh baskets, durable material, made of synthetic material - 70 x 30 mm**

		heat resistant: up to 134 °C P-touch fit laser imprint with text and barcode possible, green labels can only be engraved with text	
	92-01927	white	25 pieces
	92-01928	red	25 pieces
	92-01929	green	25 pieces
	92-01966	dark blue	25 pieces
	92-01930	light blue	25 pieces
	92-01931	orange	25 pieces
	92-01932	black	25 pieces
	92-01933	ochre yellow	25 pieces
	92-01562	yellow	25 pieces
	92-01984	pink	25 pieces
	92-01985	purple	25 pieces
	92-01959	brown	25 pieces

**PTL-Mesh basket labels with clips for marking mesh baskets, durable material, made of synthetic material - 90 x 30 mm**

		heat resistant: up to 134 °C P-touch fit laser imprint with text and barcode possible, green labels can only be engraved with text	
	92-01934	white	25 pieces
	92-01935	red	25 pieces
	92-01975	coral red	25 pieces
	92-01936	green	25 pieces
	92-01967	dark blue	25 pieces
	92-01937	light blue	25 pieces
	92-01938	orange	25 pieces
	92-01939	black	25 pieces
	92-01940	ochre yellow	25 pieces
	92-01564	yellow	25 pieces
	92-01986	pink	25 pieces



**PTL-Mesh basket labels with clips for marking mesh baskets, durable material, made of synthetic material - 90 x 30 mm**

REF		pack. unit
92-01987	purple	25 pieces
92-01958	brown	25 pieces



**Mesh basket labels, made of stainless steel, durable material**

heat resistant

92-01445	size: 90 x 33 mm with 2 holes	50 pieces
92-01444	size: 90 x 50 mm with 2 holes	50 pieces

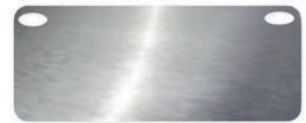

**Tags, made of stainless steel, durable material**

heat resistant

92-01452	size: Ø 25 mm with hole (4 x 9 mm)	50 pieces
92-01453	size: Ø 50 mm with hole (4 x 9 mm)	50 pieces



**Tie-on tags, made of stainless steel - size: 65 x 24 mm, durable material, with hole (6 x 10 mm)**

REF		pack. unit
92-01588	heat resistant	5 pieces



**Clipper for tie-on label - length: 40 mm**

92-01589	suitable for: tie-on tag REF 01588	1 piece
----------	------------------------------------	---------



**Mesh basket labels with clip, made of stainless steel, durable material**



REF	size	heat resistant	pack. unit
ES840.010	90 x 30 mm	heat resistant	25 pieces
ES840.020	90 x 50 mm	heat resistant	25 pieces
ES840.030	70 x 30 mm	heat resistant	25 pieces
ES840.040	55 x 30 mm	heat resistant	25 pieces
ES840.050	30 x 30 mm	heat resistant	25 pieces

**Mesh basket labels, made of stainless steel, durable material**

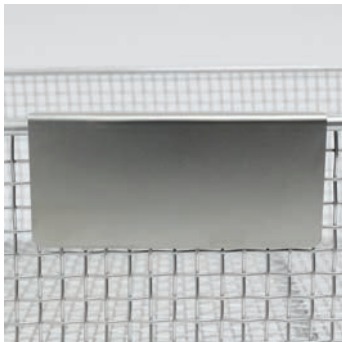

REF	size	heat resistant	pack. unit
92-01590	75 x 35 mm	heat resistant	25 pieces
92-01520	42 x 36 mm	heat resistant	25 pieces

**Laser imprints**

Text and barcode on request!





We create any kind of laser imprints on stainless steel, also on instruments.

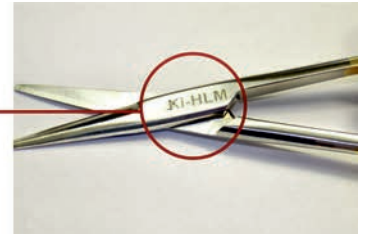
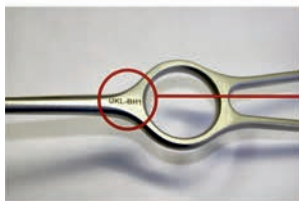

**Insertion plastic labels, durable material, made of synthetic material - 56 x 18 mm**  
REF pack. unit

heat resistant: up to 134 °C  
suitable for: mesh basket label holder REF 92-01497  
and for suitable label holders on containers  
P-touch fit  
laser imprint with text and barcode possible,  
green labels can only be engraved with text

92-01550	white	10 pieces
92-01551	red	10 pieces
92-01552	green	10 pieces
92-01553	light blue	10 pieces
92-01554	yellow	10 pieces
92-01555	orange	10 pieces
92-01556	black	10 pieces
92-01557	ochre yellow	10 pieces
92-01970	dark blue	10 pieces
92-01971	coral red	10 pieces
92-01992	pink	10 pieces
92-01993	purple	10 pieces
92-01558	brown	10 pieces



**Insertion plastic labels, durable material, made of synthetic material - 55 x 35 mm**

heat resistant: up to 134 °C  
suitable for: mesh basket label holder REF 92-01497  
and for suitable label holders on containers  
P-touch fit  
laser imprint with text and barcode possible,  
green labels can only be engraved with text

92-01566	white	25 pieces
92-01567	red	25 pieces
92-01568	green	25 pieces
92-01569	light blue	25 pieces
92-01570	yellow	25 pieces
92-01571	orange	25 pieces
92-01573	dark blue	25 pieces
92-01575	pink	25 pieces



**Insertion plastic labels, durable material, made of synthetic material - 55 x 35 mm**

REF		pack. unit
92-01576	purple	25 pieces
92-01597	black	25 pieces



**Insertion plastic labels, durable material, made of synthetic material - 70 x 35 mm**

REF		pack. unit
92-02215	white	25 pieces
92-02216	red	25 pieces
92-02217	green	25 pieces
92-02218	light blue	25 pieces
92-02219	dark blue	25 pieces
92-02220	yellow	25 pieces
92-01598	black	25 pieces



heat resistant: up to 134 °C  
 suitable for: mesh basket label holder REF 92-01497  
 and for suitable label holders on containers  
 P-touch fit  
 laser imprint with text and barcode possible,  
 green labels can only be engraved with text

**Insertion plastic labels, durable material, made of synthetic material - 90 x 35 mm**

REF		pack. unit
92-02221	white	25 pieces
92-02222	red	25 pieces
92-02223	green	25 pieces
92-02224	light blue	25 pieces
92-02225	dark blue	25 pieces
92-02226	yellow	25 pieces
92-01599	black	25 pieces



heat resistant: up to 134 °C  
 suitable for: mesh basket label holder REF 92-01497  
 and for suitable label holders on containers  
 P-touch fit  
 laser imprint with text and barcode possible,  
 green labels can only be engraved with text

**Mesh basket label holder, made of stainless steel, with clip, durable material, for PTL-plastic labels, for marking mesh baskets, 50 x 20 mm**

REF			pack. unit
-----	--	--	------------

92-01497	heat resistant		25 pieces
----------	----------------	--	-----------

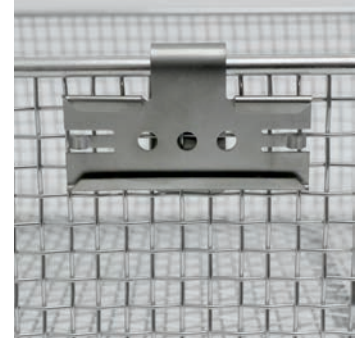
**Mesh basket label holder, made of stainless steel, with clip, for wire container, durable material, 80 x 30 mm**

92-01995	heat resistant		25 pieces
----------	----------------	--	-----------

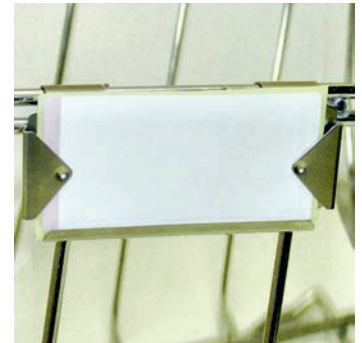
**PTL mesh basket label, durable material, 30 x 40 mm**

heat resistant: up to 134 °C  
 laser labeling: with text and barcode possible  
 suitable for: mesh basket label holder REF 92-01491  
 P-touch fit

92-02256	light red	100 pieces
92-02257	light blue	100 pieces
92-02260	white	100 pieces



**PTL mesh basket label, durable material, 55 x 40 mm**

heat resistant: up to 134 °C  
 laser labeling: with text and barcode possible  
 suitable for: mesh basket label holder REF 92-01491  
 P-touch fit

92-02262	light red	100 pieces
92-02263	light blue	100 pieces
92-02266	white	100 pieces



**PTL mesh basket label, durable material, 90 x 40 mm**

	REF		pack. unit
		heat resistant: up to 134 °C laser labeling: with text and barcode possible suitable for: mesh basket label holder REF 92-01491 P-touch fit	
	92-02268	light red	100 pieces
	92-02269	light blue	100 pieces
	92-02272	white	100 pieces

**Mesh basket label holder, made of stainless steel, with clip, durable material, for PTL-plastic labels, for marking mesh baskets, 30 x 40 mm**

	92-01491	heat resistant	25 pieces
---	----------	----------------	-----------

**Cable binder made of synthetic material - 80 x 2.3 mm - natural colour**

	92-09415	to affix mesh basket labels	250 pieces
		heat resistant: up to 134 °C	
			



### Cable binder made of synthetic material

REF		pack. unit
	to affix mesh basket labels heat resistant: up to 134 °C	
92-09461	red, size: 98 x 2.5 mm	100 pieces
92-09462	green, size: 98 x 2.5 mm	100 pieces
92-09464	yellow, size: 98 x 2.5 mm	100 pieces
92-09482	natural colour, size: 200 x 3.5 mm	100 pieces



### Cable binder made of silicone to bundle instruments

	heat resistant: up to 134 °C	
	length: 110 mm	
92-09231	natural colour	100 pieces
92-09235	red	100 pieces
92-09236	yellow	100 pieces
92-09237	green	100 pieces
92-09238	blue	100 pieces
92-09369	violet	100 pieces
92-09370	black	100 pieces
	length: 210 mm	
92-09239	red	100 pieces
92-09240	yellow	100 pieces
92-09241	green	100 pieces
92-09242	blue	100 pieces
92-09371	violet	100 pieces
92-09372	black	100 pieces

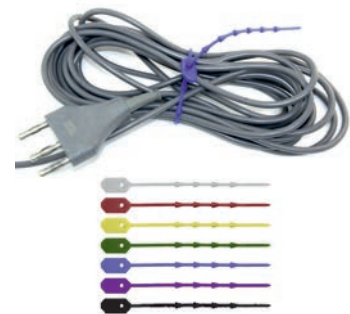

### Cable binder made of silicone to bundle instruments

	heat resistant: up to 134 °C	
	length: 60 mm (mini)	
92-09246	natural colour	100 pieces
92-09252	green	100 pieces
92-09253	blue	100 pieces
92-09254	yellow	100 pieces
92-09255	black	100 pieces
92-09256	red	100 pieces
92-09257	white	100 pieces
92-09258	orange	100 pieces
92-09259	brown	100 pieces
92-09260	grey	100 pieces
92-09261	violet	100 pieces
92-09397	light blue	100 pieces
	length: 110 mm (midi)	
92-09373	natural colour	100 pieces
92-09374	red	100 pieces
92-09375	yellow	100 pieces
92-09376	green	100 pieces
92-09377	blue	100 pieces

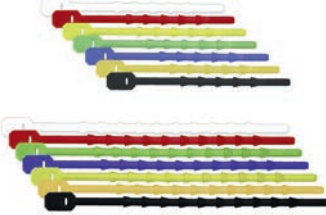

**Cable binder made of silicone to bundle instruments**

	REF		pack. unit
	92-09378	orange	100 pieces
	92-09379	black	100 pieces
	92-09282	length: 190 mm (maxi) natural colour	100 pieces
	92-09283	red	100 pieces
	92-09284	green	100 pieces
	92-09285	blue	100 pieces
	92-09286	yellow	100 pieces
	92-09381	orange	100 pieces
	92-09382	black	100 pieces

**Fixing rings for colour marking**

		to affix mesh basket labels	
		heat resistant: up to 134 °C	
		size: 10 mm inner diameter	
	92-09418	blue	100 pieces
	92-09419	green	100 pieces
	92-09420	white	100 pieces
	92-09421	red	100 pieces
	92-09422	yellow	100 pieces
	92-09423	orange	100 pieces
	92-09424	violet	100 pieces
92-09425	black	100 pieces	
92-09426	transparent	100 pieces	

**Stopper made of silicone**

		to affix mesh basket labels	
	92-09097	natural colour	100 pieces
	92-09225	blue	100 pieces
	92-09226	red	100 pieces
	92-09227	yellow	100 pieces
	92-09228	green	100 pieces

**Stopper - type 2013 made of silicone**

		to affix mesh basket labels	
	92-09465	pink	100 pieces
	92-09466	transparent	100 pieces
	92-09467	blue	100 pieces
	92-09468	red	100 pieces
	92-09469	yellow	100 pieces
92-09470	green	100 pieces	



**Stopper made of silicone - mini**

REF		pack. unit	
92-09487	to affix mesh basket labels to perforated plate mesh trays  transparent	100 pieces	

**Stopper made of synthetic material**

92-09230	to affix mesh basket labels  white	100 pieces	
----------	--	------------	---

**Bolt with raised head made of V2A - size: M4 x 8 mm**

92-08443	bolts made of V2A	50 pieces	
----------	-------------------	-----------	---

**Cap nut made of V2A for bolts - size: M4**  
REF

pack. unit

92-08444 for bolts (REF 08443), approx. 8 mm high

50 pieces



**Clamping fixture made of stainless steel - size: M4**

92-08477

Set consisting of:

100 pieces

- 1 x cap nut
- 1 x flat washer
- 1 x fixing plate



**Bolt made of V4A**

92-08952

size: M1.6 x 6 mm

100 pieces



**Flat washer made of V4A**

92-08953

size: M1.6 x 4 mm

100 pieces

92-08954

size: M2 x 7 mm

100 pieces





**Cap nut made of V4A**

REF		pack. unit
92-08955	size: M1.6	100 pieces



example of use for Aesculap-containers

**Mesh basket labels made of synthetic material, for single use only, size: 160 x 35 mm, without text**

heat resistant: up to 134 °C  
washable in washer-disinfector

92-09634	white	250 pieces
92-09635	blue	250 pieces
92-09636	green	250 pieces
92-09637	red	250 pieces
92-09638	yellow	250 pieces
92-09676	brown	250 pieces
92-09677	black	250 pieces





**Mesh basket labels made of synthetic material, for single use only, size: 236 x 50 mm, without text**

heat resistant: up to 134 °C  
washable in washer-disinfector

92-09244	white	250 pieces
92-09264	blue	250 pieces
92-09265	green	250 pieces
92-09266	red	250 pieces
92-09267	yellow	250 pieces
92-09269	orange	250 pieces



**Mesh basket labels, one-sided coloured, size: 240 x 50 mm, without text**

REF			pack. unit
		heat resistant: up to 134 °C	
92-09566		blue	250 pieces
92-09567		green	250 pieces
92-09568		red	250 pieces
92-09569		yellow	250 pieces

**Mesh basket labels made of synthetic material, for single use only, size: 206 x 110 mm, without imprint**

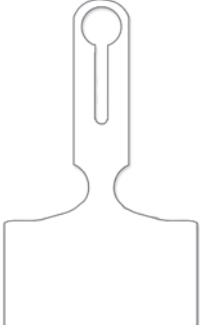
	92-09268	white heat resistant: up to 134 °C washable in washer-disinfector	250 pieces
--	----------	---	------------

**Mesh basket labels made of synthetic material, for single use only - size: "fir tree", without imprint**

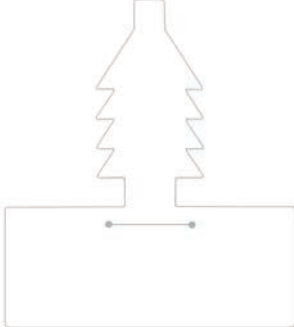
	92-09678	white heat resistant: up to 134 °C washable in washer-disinfector size: 100 x 110 mm	250 pieces
---	----------	---	------------

**Mesh basket labels made special carton, for single use only, size: 240 x 50 mm, without imprint**

	92-09751	white heat resistant: up to 134 °C material: special carton	250 pieces
---	----------	---	------------

**Mesh basket labels made of synthetic material, for single use only, size: 240 x 50 mm, green**

REF		pack. unit
92-09570	heat resistant: up to 134 °C washable in washer-disinfector "URGENT"	250 pieces

**Mesh basket labels made of synthetic material, for single use only, size: 150 x 35 mm, orange**

92-09753	heat resistant: up to 134 °C washable in washer-disinfector "Repair"	250 pieces
----------	--	------------

**Mesh basket labels made of synthetic material, for single use only, with imprint, red**

92-09755	heat resistant: up to 134 °C washable in washer-disinfector  size: 240 x 50 mm "Team-Time-out"	250 pieces
92-09752	size: 150 x 35 mm "Sharpen"	250 pieces

**Mesh basket labels made of synthetic material, for single use only, with imprint, size: 240 x 50 mm, white**

92-09762	heat resistant: up to 134 °C washable in washer-disinfector  "documentation 1 to 31 and Jan to Dec"	250 pieces
----------	--	------------



Mesh basket labels on reel, made of synthetic material, for single use only

REF

pack. unit



white  
 core diameter: 76 mm  
 with tear-off perforation  
 heat resistant: up to 134 °C  
 washable in washer-disinfector  
 individual imprint is possible

92-09691  
 92-09399

pieces per reel: 5000 pieces, size: 160 x 19 mm  
 pieces per reel: 600 pieces, size: 254 x 42 mm

1 reel  
 1 reel

Printing example for REF 92-09399

We create mesh basket labels according to your requirements, even with barcodes and graphics (minimum quantity 100 pcs.).

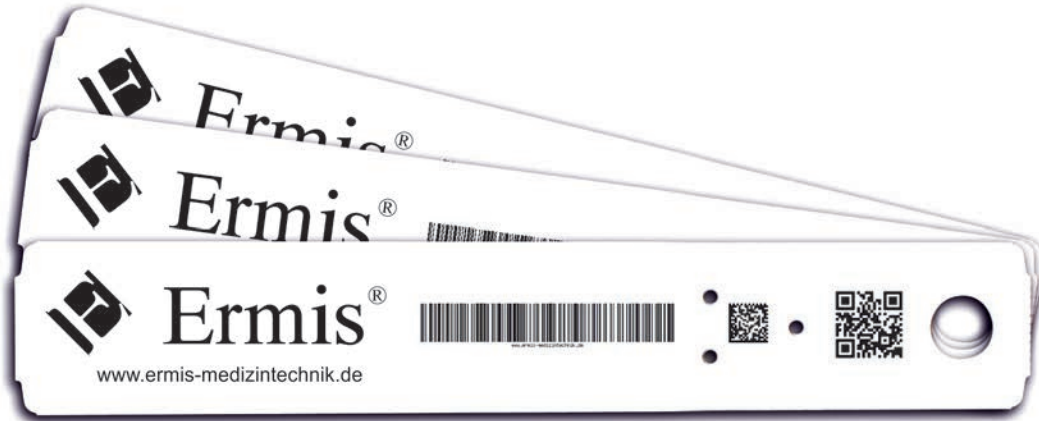

PP-Mesh basket labels - total length: 200 mm



heat resistant: up to 134 °C  
 material: polypropylene (PP)  
 washable in washer-disinfector  
 text field: 50 x 30 mm

92-09679  
 92-09680  
 92-09681  
 92-09682  
 92-09683

white  
 blue  
 green  
 red  
 yellow

100 pieces  
 100 pieces  
 100 pieces  
 100 pieces  
 100 pieces

RFID-Mesh basket label made of silicone

NEW



heat resistant: up to 134 °C  
 RFID-chip: integrated (ISO-15693)

92-08969  
 92-08965  
 92-08966  
 92-08967  
 92-08968

white  
 yellow  
 green  
 black  
 blue

1 piece  
 1 piece  
 1 piece  
 1 piece  
 1 piece

**Heat protective gloves, nitril coating**

REF

pack. unit

- allround protection for hand and wrist
- nitrile coating with fleece lining
- extremely breathable

washable: up to 40 °C  
length: 33 cm

92-09031

size: 9

1 pair

92-09034

size: 10

1 pair

**Heat protective gloves, high cut protection**

- good mechanical resilience
- heat resistant up to 100 °C
- excellent fine touch
- high cut protection
- good sweat absorption
- high wearing comfort

92-09223

size: 9

1 pair

92-09224

size: 10

1 pair

**Heat protective glove made of silicone**

- application range: -60 °C to +260 °C
- latex free

blue  
material: silicone  
washable in washer-disinfector  
size: universal

92-09263

length: 37 cm

1 piece

**Heat protective glove made of silicone**

light blue  
material: silicone  
size: universal  
washable in washer-disinfector

- application range: -40 °C to +240 °C
- structured
- latex free

92-09368

length: 35 cm

1 piece

92-09484

length: 43 cm

1 piece



#### Protective gloves made of Nomex®

REF

pack. unit



- suitable for heat and cold use
- application range: -180 °C to +260 °C
- knitted fabric for comfort
- does not shrink or melt
- hard wearing
- good chemical resistance

red  
washable  
material: Nomex®

92-09883	length: 52 cm size: 8.5 - 9	1 pair
92-09884	size: 9.5 - 10	1 pair
92-09885	size: 10.5 - 11	1 pair
92-09886	length: 30 cm size: 8.5 - 9	1 pair
92-09887	size: 9.5 - 10	1 pair
92-09888	size: 10.5 - 11	1 pair

#### Chemical protective gloves



- excellent grip-control and sense of touch
- not cotton-flocked

material: light mixture of neopren and natural latex  
material width: 0.45 mm

92-09033	size: 6.5 - 7	12 pairs
92-09032	size: 7.5 - 8	12 pairs
92-09030	size: 8.5 - 9	12 pairs



#### Protective gloves made of nitril, length 40 cm, blue

REF

pack. unit



material: made of nitrile, powder-free, latex-free  
50 pcs. / box

92-09472	size: S	1 box
92-09473	size: M	1 box
92-09474	size: L	1 box
92-09475	size: XL	1 box

#### PE-protective gloves for cleaning work



green  
material: polyethylene (soft foil)  
material width: 30  $\mu$   
with elastic band

92-09836	length: 90 cm	50 pieces
----------	---------------	-----------



**Dispenser for single use gloves, made of stainless steel**

REF		pack. unit	
	either suitable for self-supporting use or wall mounting, with screws and dowels		
92-09200	size: 262 x 152 x 90 mm	1 piece	

**Dispenser "Solo" for single use gloves, made of stainless steel**

	for wall mounting, with screws and dowels		
92-09202	size: 250 x 135 x 95 mm	1 piece	

**Dispenser "Trio" for single use gloves, made of stainless steel**

	with size identification S, M and L, for wall mounting, with screws and dowels		
92-09201	size: 258 x 392 x 96 mm	1 piece	

**Standard hospital rail adapter for glove dispenser REF 09201 "Trio" and REF 09202 "Solo"**

	material: stainless steel		
92-20439	size: 202 x 23 x 37 mm	1 piece	

#### Safety goggles

	REF		pack. unit
		frames for 2-piece safety goggles	
	92-09081	frame colour: yellow	10 pieces
	92-09431	frame colour: pink	10 pieces
		Visors for 2-piece safety goggles	
	92-09082	material: plastic	25 pieces

#### Protective shield

	92-09417	<ul style="list-style-type: none"> <li>• low reflection</li> <li>• equipped with anti-fog</li> <li>• with elastic strap</li> </ul>	10 pieces
--	----------	--	-----------

#### POLYDENTIA VISTA-TEC ultra light classic protective shield

		<ul style="list-style-type: none"> <li>• excellent protection</li> <li>• made of transparent foil</li> <li>• high scratch- and abrasion-resistance</li> <li>• does not reflect the light</li> <li>• does not turn yellow at daylight</li> <li>• feathery (16 g)</li> <li>• angle and height adjustable</li> </ul>	
		Set consisting of: <ul style="list-style-type: none"> <li>• 1 frame</li> <li>• 10 shields</li> <li>• 2 clipon for spectacle wearers</li> </ul>	
	92-09405	frame colour: white	1 set
	92-09406	frame colour: blue	1 set
	92-09407	frame colour: transparent	1 set
	92-09408	frame colour: pink	1 set
	92-09427	frame colour: yellow	1 set
	92-09428	frame colour: green	1 set

**Shields for POLYDENTIA VISTA-TEC ultra light classic protective shield**

 REF pack. unit

 92-09414      10 shields (without frames) 1 set

**POLYDENTIA VISTA-TEC Clipon protective shield for spectacle wearers**

 92-09409 1 set

- compatible with almost all spectacles and head-worn loupe systems;
- with plastic-clips for firm attachment

Set consisting of:

- 5 x shields
- 2 x clipon for spectacle wearers

**POLYDENTIA VISTA-TEC frames**

	frame colour:	
92-09410	white	1 piece
92-09411	blue	1 piece
92-09412	transparent	1 piece
92-09413	pink	1 piece
92-09429	yellow	1 piece
92-09430	green	1 piece

**Protective gowns, universal size, length 136 cm**

- non-woven protective gown, non-sterile
- for single use
- breathable (back side)
- partially lined
- water resistant (front side and sleeves)
- to be worn on the unclean side of the CSSD
- for protection against contaminants
- long sleeves with rubber cuff
- covers entire front and back of upper part of the body



92-09401	light yellow, material width: 30 g/m <sup>2</sup>	100 pieces
92-09402	orange, material width: 15 g/m <sup>2</sup>	100 pieces

#### Protective gowns, universal size, length 130 cm

REF

pack. unit

92-09437

50 pieces



- spunbonded protective gown, non-sterile
- for single use
- breathable
- water resistant
- to be worn on the unclean side of the CSSD
- for protection against contaminants
- long sleeves with elastic cuff
- to tie at the waist
- covers entire front and back of upper part of the body

blue

material width: 72 g/m<sup>2</sup>

#### Protective gowns, XXL, length 150 cm

92-09442

100 pieces



- non-woven protective gown
- non-sterile
- for single use
- water resistant
- breathable
- partially lined (front side and sleeves)
- long sleeves with rubber cuff

white

material width: 30 g/m<sup>2</sup>

#### Visitor gown, made of non-woven, universal size, length 120 cm

92-09480

100 pieces



- non-sterile
- for single use
- breathable
- uncoated
- long sleeves with rubber cuff

dark green

material width: 15 g/m<sup>2</sup>

#### Arm cover, length 40 cm

92-09438

100 pieces



- moisture-proof
- sturdy
- with rubber cuff

white

material: polyethylene (PE)

material width: 20 μ

**Masks, 3 layers**

REF		pack. unit
	with elastic ear-loop	
	blue-white	
92-09440	without visor, 50 pieces / box	1 box
92-09441	with visor, 20 pieces / box the protective foil must be removed prior to the first use	1 box

**Neck-warmer (turtle neck)**

	<ul style="list-style-type: none"> <li>• made of 100 % cotton</li> <li>• anti-pilling</li> <li>• preshrunk</li> <li>• oeko-tex standard 100</li> </ul>	
92-09439	size: S	1 piece
92-09403	size: M	1 piece
92-09404	size: L	1 piece





#### Hearing Protector, EARCAPS

	REF		pack. unit
	92-09433	<ul style="list-style-type: none"> <li>• with clamp</li> <li>• (replacement earplugs: REF 09434)</li> </ul>	1 piece

#### Replacement earplugs for REF 09432 and REF 09433

	92-09434	20 pcs./box	1 box
--	----------	-------------	-------

#### Ear plugs "EARSoft Yellow Neons"

 	92-09444	<ul style="list-style-type: none"> <li>• made of polyurethane foam, which slowly restores to the original shape</li> <li>• pack: 250 pairs</li> </ul>	1 pack
---	----------	---	--------

#### Dispenser EAR Classic 2 for earplugs

	92-09435	<p>The dispenser delivers earplugs quickly and easily. Versatile design includes tabletop or wall-mount options.</p> <p>Incl. 1000 earplugs / dispenser</p>	1 dispenser
---	----------	---	-------------

**Shoe automat for overshoes**

REF

pack. unit

92-09965 casing made of aluminum  
size: 470 x 255 x 170 mm

1 piece

**Shoe cover for shoe cover machines - refill pack**

92-09964 9 pouches of 200 pcs.  
material thickness: 20  $\mu$   
size: 16 x 51 cm

1800 pieces

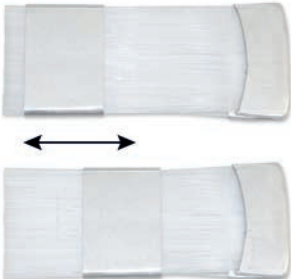

### Brush with sliding cover and nylon bristles

	REF		pack. unit
	92-26029	length: 55 mm, width: 23 mm  hardness of bristles: adjustable	3 pieces

### Cleaning brushes with nylon bristles for MIS instruments

heat resistant: up to 134 °C  
washable in washer-disinfector

	brush diameter	brush length	total length		
	92-09339	2.0 mm	100 mm	300 mm	5 pieces
	92-09342	2.0 mm	60 mm	300 mm	5 pieces
	92-09308	2.5 mm	50 mm	300 mm	5 pieces
	92-09340	2.5 mm	100 mm	300 mm	5 pieces
	92-09343	2.5 mm	80 mm	400 mm	5 pieces
	92-09050	2.5 mm	30 mm	500 mm	5 pieces
	92-09313	2.5 mm	50 mm	610 mm	5 pieces
	92-09341	3.0 mm	100 mm	300 mm	5 pieces
	92-09344	3.0 mm	100 mm	450 mm	5 pieces
	92-09335	3.5 mm	100 mm	250 mm	5 pieces
	92-09346	3.5 mm	35 mm	500 mm	5 pieces
	92-09052	4.0 mm	100 mm	300 mm	5 pieces
	92-09345	4.0 mm	100 mm	500 mm	5 pieces
	92-09336	5.0 mm	100 mm	250 mm	5 pieces
	92-09306	5.0 mm	100 mm	300 mm	5 pieces
	92-09318	5.0 mm	80 mm	405 mm	5 pieces
	92-09324	5.0 mm	35 mm	500 mm	5 pieces
	92-09312	5.0 mm	100 mm	610 mm	5 pieces
	92-09317	5.0 mm	100 mm	650 mm	5 pieces
	92-09053	6.0 mm	100 mm	300 mm	5 pieces
	92-09307	7.0 mm	100 mm	300 mm	5 pieces
	92-09051	7.0 mm	80 mm	350 mm	5 pieces
	92-09068	7.0 mm	100 mm	500 mm	5 pieces
	92-09311	7.0 mm	100 mm	610 mm	5 pieces
	92-09316	7.0 mm	100 mm	650 mm	5 pieces
	92-09054	8.0 mm	100 mm	300 mm	5 pieces
	92-09055	10.0 mm	100 mm	300 mm	5 pieces
	92-09310	10.0 mm	100 mm	610 mm	5 pieces
	92-09315	10.0 mm	100 mm	650 mm	5 pieces
	92-09309	12.0 mm	100 mm	610 mm	5 pieces
	92-09314	12.0 mm	100 mm	650 mm	5 pieces
	92-09056	15.0 mm	100 mm	300 mm	5 pieces
92-09066	15.0 mm	100 mm	800 mm	5 pieces	
92-09332	20.0 mm	100 mm	500 mm	5 pieces	
92-09059	30.0 mm	80 mm	300 mm	5 pieces	
92-09334	40.0 mm	60 mm	500 mm	5 pieces	



**Cleaning brushes set**

REF				pack. unit
92-09057	Set consisting of REF 09050-09056			1 set
	brush diameter	brush length	total length	
92-09050	2.5 mm	30 mm	500 mm	1 piece
92-09051	7.0 mm	80 mm	350 mm	1 piece
92-09052	4.0 mm	100 mm	300 mm	1 piece
92-09053	6.0 mm	100 mm	300 mm	1 piece
92-09054	8.0 mm	100 mm	300 mm	1 piece
92-09055	10.0 mm	100 mm	300 mm	1 piece
92-09056	15.0 mm	100 mm	300 mm	1 piece

**Cleaning brushes for Frazier suction tubes, total length 215 mm**

REF	brush diameter	brush length	colour	pack. unit
heat resistant: up to 134 °C washable in washer-disinfector				
92-45906	1.6 mm	22 mm	white	3 pieces
92-45908	2.0 mm	21 mm	black	3 pieces
92-45910	2.5 mm	21 mm	pink	3 pieces
92-45912	3.0 mm	18 mm	orange	3 pieces

**Cleaning brushes for instruments, total length 450 mm**

REF	brush diameter	brush length	pack. unit
heat resistant: up to 134 °C washable in washer-disinfector brush length: 13 mm			
92-09095	brush diameter: 1.0 mm		2 pieces
92-09319	brush diameter: 1.8 mm		2 pieces

**Cleaning brush / single use**

REF	brush diameter	brush length	total length	pack. unit
brush diameter: 5.0 mm brush length: 20 mm				
92-09049			total length: 150 mm	100 pieces
92-09322			total length: 200 mm	100 pieces



### Cleaning brush with nylon bristles for spouts, total length 140 mm

REF		pack. unit
92-09303	brush diameter: 10.0 mm brush length: 45 mm	5 pieces



### Cleaning brush with nylon bristles for Bülau bottles, total length 650 mm

92-09458	brush diameter: 40.0 mm brush length: 60 mm	5 pieces
----------	--	----------





### Cleaning brush for bone reamer, total length 800 mm

	92-09490	brush length: 100 mm wire made of V2A brush tip: deburred brush diameter: 3.0 mm	3 pieces
	92-09492	brush tip: with cap brush diameter: 5.0 mm	3 pieces
	92-09491	brush tip: with cap brush diameter: 7.0 mm	3 pieces

### Cleaning brushes for instruments with covered wire, tapered brush head

	92-09333	brush diameter: 15.0 - 20.0 mm brush length: 100 mm total length: 280 mm	1 piece
	92-09380	total length: 460 mm	1 piece

**Disposable cleaning brush, double-sided, for acetabular reamers**

REF		pack. unit	
92-26023	<ul style="list-style-type: none"> <li>• round brush end - length: 45 mm, Ø 40 mm</li> <li>• conical brush end - length: 25 mm, Ø 8 mm</li> </ul> <p>white total length: 190 mm</p>	3 pieces	 



**Cleaning brush for instruments with plastic grip**

92-09338	brush diameter: 3.5 mm brush length: 60 mm total length: 265 cm	2 pieces	
----------	---	----------	---

**Cleaning brush for rectoscopes**

92-09331	washable in washer-disinfector brush diameter: 20.0 mm brush length: 150 mm total length: 450 mm	5 pieces	
----------	---	----------	---

**Cleaning brush for anos-, proctos- and rectoscopes**

92-09096	brush tip: with cap, wire made of V2A washable in washer-disinfector bristle material: nylon handle of brushes: with 110 mm nylon handle brush diameter: 20.0 mm brush length: 70 mm total length: 270 mm	1 piece	 
----------	---	---------	---

## Brush for suction tubes

	REF		pack. unit
		number of brush heads: 2 brush length: 20 mm (nylon) / 30 mm (pipe cleaner) total length: 390 mm for single use	
	92-26480	brush diameter: 3.0 mm blue	10 pieces
	92-26481	brush diameter: 6.0 mm yellow	10 pieces

## Disposable cleaning brushes for instruments, single sided, the first 90 mm are without bristles

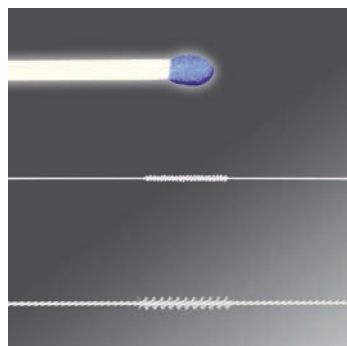

		heat resistant: up to 134 °C brush length: 8 mm total length: 450 mm	
92-09366	brush diameter: 0.6 mm		5 pieces
92-09388	brush diameter: 1.4 mm		5 pieces

## Cleaning brush with nylon bristles, double sided



92-09098	heat resistant: up to 134 °C bristle length: 5 and 10 mm brush length: 25 and 35 mm total length: 175 mm	2 pieces
----------	---	----------

## Cleaning brush, double sided, with extra strong synthetic bristles for stubborn soils



92-09459	blue heat resistant: up to 134 °C bristle length: 10 mm brush length: 30 and 40 mm total length: 175 mm	2 pieces
----------	---	----------

**Cleaning brush with synthetic bristles for instruments, double sided**

REF		pack. unit
92-09064	bristle length: 15 and 12 - 15 mm brush length: 10 and 30 mm total length: 155 mm	12 pieces

**Cleaning brush, with extra strong synthetic bristles for stubborn soils**

92-09320	blue heat resistant: up to 134 °C washable in washer-disinfector bristle length: 12 mm brush length: 30 and 45 mm total length: 165 mm	10 pieces
----------	---	-----------

**Cleaning brush, with extra strong bristles for stubborn soils**

	blue heat resistant: up to 134 °C washable in washer-disinfector bristle length: 15 mm brush length: 75 mm	
92-09460	total length: 215 mm	2 pieces
92-09485	handle of brushes: angled, total length: 235 mm	2 pieces

**Cleaning brush, with soft synthetic bristles**

92-09478	blue heat resistant: up to 134 °C washable in washer-disinfector bristle length: 15 mm bristle material: plastic brush length: 75 mm total length: 215 mm	1 piece
----------	---	---------



## Cleaning brushes for stubborn soils

REF		pack. unit
		
92-09325	light blue, bristle material: stainless steel	1 piece
92-09489	bristle material: brass	1 piece
92-09488	bristle material: synthetic	1 piece

bristle length: 15 mm  
brush length: 40 mm  
total length: 180 mm

Please pay attention to careful use as sensitive surfaces could be damaged with stainless steel and brass bristles.

## Disposable cleaning brush for instruments, single sided

	92-26024	brush diameter: 2.5 mm for flexible scopes and instruments with a channel size of: 1.4 - 2.0 mm brush length: 14 mm total length: 230 cm yellow tube diameter: 1.2 mm	50 pieces
--	----------	--	-----------





## Disposable cleaning brushes for instruments, double sided

	92-26090	brush diameter: 2.0 mm for flexible scopes and instruments with a channel size of: 1.2 mm total length: 230 cm transparent	100 pieces
---	----------	---	------------

## Reusable cleaning brushes for instruments, double sided, single packed

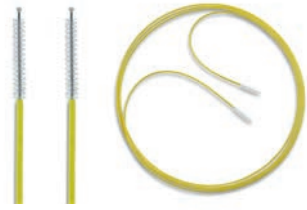
	92-09352	brush diameter: 2.0 mm for flexible scopes and instruments with a channel size of: 1.2 - 1.5 mm brush length: 12 mm total length: 100 cm yellow	1 piece
	92-09353	brush diameter: 3.0 mm for flexible scopes and instruments with a channel size of: 2.0 - 2.2 mm brush length: 12 mm total length: 100 cm white	1 piece

**Disposable cleaning brushes for instruments, double sided, single packed**

REF		pack. unit	
92-26022	Cleaning Brush Double Sided brusch diameter (valve): 3.0 mm for flexible scopes and instruments with a channel size from 2.0 mm brush surface length (valve): 20.0 mm total length: 250 cm yellow	50 pieces	
92-26020	brush diameter: 5.0 mm for flexible scopes and instruments with a channel size of: 2.8 - 4.2 mm brush length: 20 mm total length: 230 cm red	50 pieces	
92-26021	brush diameter: 6.0 mm for flexible scopes and instruments with a channel size of: 2.8 - 4.5 mm brush length: 20 mm total length: 230 cm turquoise	50 pieces	
92-26482	brush diameter: 6.0 mm for flexible scopes and instruments with a channel size of: 2.8 - 4.5 mm brush length: 20 mm total length: 360 cm green	50 pieces	

**Disposable set of cleaning brushes for endoscopes, non-sterilizable**

92-09356	Set consisting of: <ul style="list-style-type: none"> <li>• double-sided endoscope brush, blue, total length: 257 cm, brush diameter: 6.5 mm, brush length: 20 mm</li> <li>• double-sided valve cleaning brush, yellow, total length: 150 mm, brush diameter: 4.5 mm, brush length: 18 mm / brush diameter: 10 mm, brush length: 30 mm</li> </ul>	1 set	
----------	---	-------	---

**Disposable instrument cleaning brush, double-sided, with pipe cleaner and nylon brush**

92-26305	brush diameter: 3.0 mm for flexible scopes and instruments with a channel size of: 2.0 - 2.8 mm brush length: 20 mm (nylon) / 300 mm (pipe cleaner) total length: 230 cm blue	50 pieces	
----------	--	-----------	---

### Disposable instrument cleaning brush, double-sided, with pipe cleaner and nylon brush

REF		pack. unit
92-26026	 <p>brush diameter: 5.0 mm for flexible scopes and instruments with a channel size of: 2.8 - 4.0 mm brush length: 20 mm (nylon) / 310 mm (pipe cleaner) total length: 265 cm yellow</p>	50 pieces

### Disposable cleaning brushes for instruments, double sided, tapered brush heads, single packed

92-26025	 <p>brush diameter: 4 - 6 mm / 3 - 5 mm (conical) for flexible scopes and instruments with a channel size of: 2.8 - 4.5 mm brush length: 20 mm total length: 230 cm yellow</p>	50 pieces
----------	--	-----------

### Disposable cleaning brushes for instruments, double sided, with one valve and one channel cleaning brush

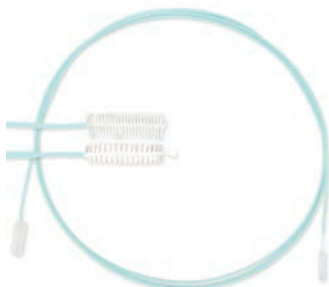

92-26028	 <p>brush diameter: channel brush 5.5 mm / valve brush 10.0 mm for flexible scopes and instruments with a channel size of: 2.8 - 4.5 mm brush diameter: 5.5 mm / 10.0 mm total length: 230 cm turquoise</p>	50 pieces
----------	--	-----------

### Disposable valve cleaning brush, double-sided



92-26027	 <p>brush diameter: 5.2 mm / 11.0 mm total length: 156 mm red for single use</p>	100 pieces
----------	---	------------



**Racks for brushes to hang up brushes**

REF		pack. unit	
	for wall mounting, incl. screws and dowels		
92-06011	white length: 260 mm racks for brushes: 8-fold material: plastic	1 piece	
92-06012	length: 300 mm racks for brushes: 10-fold material: stainless steel	1 piece	
92-06021	length: 600 mm racks for brushes: 20-fold material: stainless steel	1 piece	

**Leonardo-Wet-Set**

	For transport storage of EndoWrist® instruments, keeps the distal end moist and facilitates the reprocessing. Protects the instrument tip during transport.		
92-50055	Set consisting of: <ul style="list-style-type: none"> <li>• 3 tubes</li> <li>• 3 caps</li> </ul>	1 set	
92-50058	Set consisting of: <ul style="list-style-type: none"> <li>• 20 tubes</li> <li>• 20 caps</li> </ul>	1 set	

**Lubrinol**

92-02004	Lubrinol maintenance oil for surgical instruments has a high creeping effect, excellent lubricating qualities for joints and is physiologically safe. The cleaned instruments have to be sprayed at a distance of 20 - 30 cm and then be sterilized. Lubrinol is suitable for steam sterilization at 134 °C.  content: 400 ml	1 aerosol	
----------	---	-----------	---

**Lubrifiuid**

92-02008	lubricant for maintenance of all Bien-Air handpieces, contra-angles and air motors  content: 500 ml	1 aerosol	
----------	---	-----------	---

## Enginol



REF

pack. unit

92-02006

Enginol is a special maintenance oil for compressed air machines. Not suitable for high speed motors.

1 bottle

content: 50 ml

## Chirol ultra



92-02110

Chirol ultra is the solution for particularly strong and obstinate contamination on metallic surfaces. With Chirol ultra you can easily remove silicate coatings, burnt adhesive-tape residues and dried sterilized blood from the instrument joints. It is especially suitable for container maintenance. Chirol ultra supersedes the use of acids and organic solvents (ether, surgical spirit). Metallic surfaces are cleaned highly effective. Also suitable for coated aluminium. Chirol ultra is water-soluble and contains no solvent.

1 bottle

content: 250 ml

## AZO GEL



92-02119

instrument pre-cleaning gel

1 bottle

content: 750 ml

## Tape-Ex



92-02111

"Tape-Ex" removes stubborn soils and residues of glue from adhesive tapes and labels.

1 aerosol

content: 300 ml

**HygoTopp dispenser (without content)**

REF

pack. unit

92-02018	lid colour: white
92-02019	lid colour: blue
92-02020	lid colour: red
92-02021	lid colour: green
92-02022	lid colour: yellow

1 piece  
1 piece  
1 piece  
1 piece  
1 piece



**HygoTopp non-woven reel**

92-02023	90 towels / reel
	white
	60 g/m <sup>2</sup>

6 reels



### Floor and cleaning wipes "Volumen"

	REF		pack. unit
	92-1138040	with tear-off perforation, 500 towels / reel  white size: 30 x 38 cm 80 g/m <sup>2</sup>	2 reels

### Floor stand for floor and cleaning wipes

	92-9010005	width: 40 cm, for REF 1138040	1 piece
--	------------	-------------------------------	---------

### Floor and cleaning wipes

	92-1210001	600 pcs. (30 x 20 pcs.)  white size: 33 x 37 cm 100 g/m <sup>2</sup>	600 pieces
---	------------	--	------------

### Rubber "Poraflex" W8

		for cleaning metal surfaces	
	92-02120	size: 40 x 25 x 12 mm "Ultra"	1 piece
	92-02121	Rubber "Poraflex" W8 stick set size: 80 x 10 x 10 mm  Set consisting of: • holder • two rubber pencil leads	1 set
	92-02122	size: 80 x 10 x 10 mm "Stick", two rubber pencil leads	2 pieces

**Stain & rust remover pad**

REF		pack. unit
	remover pad for the effortless removal of rust and other soils, pack: 3 pcs. Warning: The pads could alter the surface and should not be used on coated or chromed surfaces or similar objects.	
	size: 150 x 100 mm	
92-02117	colour: grey - very smooth	1 pack
92-02118	colour: brown - rough	1 pack

**Polishing wheel for polishing machine REF 92-08518, for metal polishing**

92-08519	polishing wheel diameter: 19 mm fine / orange	6 pieces
92-08520	medium / blue	6 pieces
92-08521	rough / red	6 pieces
92-08524	polishing wheel diameter: 25 mm rough / yellow	6 pieces

**Mandrel "standard", suitable for REF 92-08518**

92-08527	Ø 2.34 mm, for polishing wheel Ø 19 mm	10 pieces
----------	--	-----------



### Particle exhauster for polishing set REF 08518

REF		pack. unit
92-08522	 <ul style="list-style-type: none"> <li>• exhaust of particles during the cleaning process</li> <li>• filter can be changed easily (spare filter triple pack REF 08523)</li> <li>• delivery with one filter</li> <li>• filter size: 130 x 130 mm</li> <li>• acoustic level: 43 dB</li> <li>• class: 94/EN779</li> <li>• weight: 1.4 kg</li> <li>• size: 220 x 270 x 168 mm</li> </ul>	1 piece
92-08523	Replacement filterset for REF 92-08522 size: 130 x 130 mm 3 filters / set	1 set

### Disinfectant dispenser "disinfect"

92-09962	 <ul style="list-style-type: none"> <li>• with battery or mains adapter</li> <li>• with drip pan</li> <li>• fixing material for stable installation</li> <li>• contactless activation</li> <li>• bottles from 0.5 to 1 litre can be used</li> <li>• display with background lighting</li> <li>• dispensed amount shown on the display</li> <li>• sizes: height: 499 mm, width: 205 mm, depth: 239 mm (with drip pan)</li> </ul>	1 piece
----------	---	---------

### Steritron® - touchless disinfection unit

92-09963	 <p>Steritron® is a unique spraying device for touchless hand disinfection. It covers both hands equally with disinfection liquid. A preset dosage is delivered automatically, simply by positioning the hands under the spraying nozzle. It works with all known disinfection liquids (1.0 litre containers).</p> <ul style="list-style-type: none"> <li>• power input: 12V DC / 0.4A with power adaptor</li> <li>• fluid dosage: 0.5 - 5 ml (10 steps)</li> <li>• housing: powder coated aluminium</li> <li>• sizes: 280 mm high, 182 mm wide, 106 mm deep</li> </ul>	1 piece
----------	--	---------



**Tip guards for Steinmann nails**

REF	colour	diameter	pack. unit
	sterilizable: with steam 121/134 °C and EO material: vinyl		
92-01053	blue	3.5 mm	100 pieces
92-01054	green	4.0 mm	100 pieces
92-01055	brown	4.5 mm	100 pieces
92-01056	black	5.0 mm	100 pieces
92-01057	grey	10.0 mm	100 pieces



**Tip guards for optics**

	sterilizable: with steam 121/134 °C and EO tapered		
92-01058	colour red	diameter 8.0 mm	100 pieces



**Tip guards for ocular funnels**

	sterilizable: with steam 121/134 °C and EO round			
92-01861	colour black	diameter 31.8 mm	height 6.4 mm	100 pieces



**Tip guards made of transparent vinyl**

	transparent sterilizable: with steam 121/134 °C and EO tapered		
92-01050	size: 1, Ø approx. 2.0 mm - corresponds to ch. 10		100 pieces
92-01051	size: 2, Ø approx. 3.5 mm - corresponds to ch. 12		100 pieces
92-30405	size: 3, Ø approx. 4.8 mm - corresponds to ch. 16		100 pieces
92-3-03-08	diameter: 15.0 mm length: 35.0 mm		100 pieces



**Tip guards for kirschner wires - Ø 1,5 mm**  
REF

pack. unit



92-01059	sterilizable: with steam 121/134 °C and EO tapered	colour white	diameter 1.5 mm	length 15.0 mm	10 pieces
----------	--	-----------------	--------------------	-------------------	-----------

**Tip guards, vented, round**



	sterilizable: with steam 121/134 °C and EO material: vinyl				
92-01484	colour clear	diameter 1.6 mm	length 19.0 mm	100 pieces	
92-01485	clear	2.0 mm	19.0 mm	100 pieces	
92-01486	clear	2.8 mm	19.0 mm	100 pieces	
92-01487	clear	3.2 mm	25.4 mm	100 pieces	
92-01488	clear	5.0 mm	25.0 mm	100 pieces	
92-01489	clear	10.0 mm	19.0 mm	100 pieces	

**Tip guards, vented, tinted, round**



	sterilizable: with steam 121/134 °C and EO round material: vinyl				
92-01461	colour blue	diameter 2.0 mm	length 19.0 mm	100 pieces	
92-01462	green	2.8 mm	19.0 mm	100 pieces	
92-01465	violet	10.0 mm	19.0 mm	100 pieces	

**Precision tip guards, vented, tinted, round**



	sterilizable: with steam 121/134 °C and EO round material: vinyl				
92-30006	colour white	diameter 1.6 mm	length 19.0 mm	100 pieces	
	replacement for REF 92-01460				
92-30009	red	3.2 mm	25.4 mm	100 pieces	
	replacement for REF 92-01463				
92-30010	yellow	5.0 mm	25.0 mm	100 pieces	
	replacement for REF 92-01464				





**Tip guards for Verres needles, vented**

REF				pack. unit
	sterilizable: with steam 121/134 °C and EO			
92-01856	colour clear	diameter 2.0 mm	length 19.0 mm	50 pieces



**Tip guards for trocar probes, vented**

REF				pack. unit
	sterilizable: with steam 121/134 °C and EO material: vinyl			
92-01857	colour clear	diameter 5.0 mm	length 20.0 mm	25 pieces
92-01858	colour clear	diameter 5.0 mm	length 43.0 mm	20 pieces
92-01859	colour clear	diameter 10.0 mm	length 20.0 mm	25 pieces
92-01860	colour clear	diameter 10.0 mm	length 57.0 mm	20 pieces



**Tip guards for Osteotomes, vented**

REF				pack. unit
	sterilizable: with steam 121/134 °C and EO rectangular material: vinyl			
92-01806	colour clear	width 6.4 mm	height 19 mm	50 pieces
92-01807	colour clear	width 9.5 mm	height 25.0 mm	50 pieces
92-01808	colour clear	width 12.7 mm	height 25.0 mm	50 pieces
92-01809	colour clear	width 19.0 mm	height 25.4 mm	50 pieces
92-01811	colour clear	width 32.0 mm	height 32.0 mm	50 pieces
92-01812	colour clear	width 38.0 mm	height 38.0 mm	50 pieces
92-01813	colour clear	width 44.5 mm	height 32.0 mm	50 pieces



**Web guards**

REF				pack. unit
	sterilizable: only with low heat and H <sub>2</sub> O <sub>2</sub> material: polyethylene (PE)			
92-01850	colour orange	width 10.0 mm	height 76.0 mm	24 pieces
92-01851	colour green	width 15.0 mm	height 76.0 mm	24 pieces
92-01852	colour blue	width 20.0 mm	height 76.0 mm	24 pieces
92-01853	colour red	width 40.0 mm	height 76.0 mm	24 pieces
92-01854	colour black	width 60.0 mm	height 76.0 mm	16 pieces
92-01855	colour white	width 70.0 mm	height 76.0 mm	16 pieces

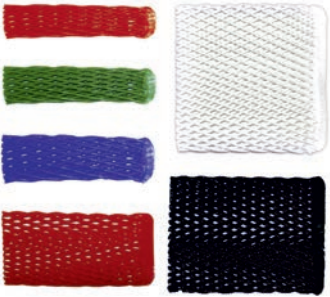

**Tip guards, vented, tinted**

REF

pack. unit

sterilizable: with steam 121/134°C and EO  
tapered  
length: 38.0 mm  
material: vinyl



- 92-01826
- 92-01827
- 92-01828
- 92-01829
- 92-01830
- 92-01831
- 92-01832
- 92-01833
- 92-01834
- 92-01835
- 92-01836
- 92-01837

- colour
- white
  - blue
  - green
  - red
  - yellow
  - violet
  - orange
  - brown
  - black
  - green
  - yellow
  - orange

- suitable instrument tips ø
- 2 - 3 mm
  - 3 - 4 mm
  - 4 - 5 mm
  - 5 - 6 mm
  - 6 - 7 mm
  - 7 - 8 mm
  - 8 - 9 mm
  - 9 - 10 mm
  - 10 - 11 mm
  - 15 - 16 mm
  - 19 - 20 mm
  - 21 - 22 mm

- 70 pieces
- 70 pieces
- 70 pieces
- 70 pieces
- 70 pieces
- 70 pieces
- 70 pieces
- 70 pieces
- 70 pieces
- 50 pieces
- 50 pieces
- 50 pieces

**Tip guards, vented, tinted**

sterilizable: with steam 121/134 °C and EO  
tapered  
length: 51.0 mm  
material: vinyl



- 92-01838
- 92-01839
- 92-01840
- 92-01841
- 92-01842
- 92-01843
- 92-01844
- 92-01845
- 92-01846
- 92-01847
- 92-01848

- colour
- white
  - blue
  - green
  - red
  - yellow
  - violet
  - orange
  - brown
  - black
  - green
  - yellow

- suitable instrument tips ø
- 2 - 3 mm
  - 3 - 4 mm
  - 4 - 5 mm
  - 5 - 6 mm
  - 6 - 7 mm
  - 7 - 8 mm
  - 8 - 9 mm
  - 9 - 10 mm
  - 10 - 11 mm
  - 15 - 16 mm
  - 19 - 20 mm

- 70 pieces
- 70 pieces
- 70 pieces
- 70 pieces
- 70 pieces
- 70 pieces
- 70 pieces
- 70 pieces
- 70 pieces
- 50 pieces
- 50 pieces

**Twin-tip guards, tinted, vented**



- 92-01800
- 92-01801
- 92-01802
- 92-01803
- 92-01804
- 92-01805

sterilizable: with steam 121/134 °C and EO  
material: vinyl

- | colour | diameter | length  |           |
|--------|----------|---------|-----------|
| white  | 1.6 mm   | 19.0 mm | 50 pieces |
| blue   | 2.0 mm   | 19.0 mm | 50 pieces |
| green  | 2.8 mm   | 19.0 mm | 50 pieces |
| red    | 3.2 mm   | 25.0 mm | 50 pieces |
| yellow | 5.0 mm   | 25.0 mm | 50 pieces |
| orange | 2.0 mm   | 25.0 mm | 50 pieces |

**Tip guards for retractors**

REF		pack. unit
	clear sterilizable: with steam 121/134 °C and EO material: vinyl	
92-01814	length: 38.0 mm	55 pieces
92-01815	length: 51.0 mm	45 pieces
92-01816	length: 76.0 mm	40 pieces

**Tip guards for Weitlaner-retractor**

	opening: small: 25 x 13 mm medium: 32 x 13 mm	
	sterilizable: with steam 121/134 °C and EO material: vinyl	
92-01472	colour: magenta size: small	50 pieces
92-01473	colour: clear size: small	50 pieces
92-01474	colour: green size: medium	50 pieces
92-01475	colour: clear size: medium	50 pieces

**Precision tip guards with raised inner nubs, vented**

	sterilizable: with steam 121/134 °C rectangular material: TPE height: 25 mm	
92-30005	colour: natural colour depth: 2.0 mm width: 9.0 mm	100 pieces
92-30000	colour: orange depth: 2.0 mm width: 9.0 mm	100 pieces
92-30002	colour: black depth: 3.0 mm width: 25.0 mm	100 pieces
92-30001	colour: natural colour depth: 3.0 mm width: 25.0 mm	100 pieces
92-30016	colour: natural colour depth: 2.0 mm width: 16.0 mm	100 pieces
92-30017	colour: brown depth: 2.0 mm width: 16.0 mm	100 pieces

**Precision tip guards for Osteotomes with raised inner nubs, vented**

	sterilizable: with steam 121/134 °C rectangular material: TPE	
92-30004	colour: natural colour width: 6.4 mm height: 19.0 mm	50 pieces
92-30003	colour: natural colour width: 19.0 mm height: 25.4 mm	50 pieces



**Leonardo-Wet-Set**

	REF		pack. unit
	92-50055	For transport storage of EndoWrist® instruments, keeps the distal end moist and facilitates the reprocessing. Protects the instrument tip during transport.	1 set
		Set consisting of: <ul style="list-style-type: none"> <li>• 3 tubes</li> <li>• 3 caps</li> </ul>	
	92-50058	Set consisting of: <ul style="list-style-type: none"> <li>• 20 tubes</li> <li>• 20 caps</li> </ul>	1 set

**Single use tip protectors, made of transparent film**

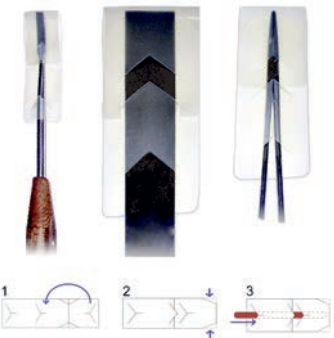

How to use: First, the shorter flap is folded to the back and then pushed beneath the V-shaped opening. For narrow instruments the folding borders on each side can be folded inwards to prevent the instruments from slipping out. Lastly, the instruments are pushed through the punched openings, as shown in Figure 3.

heat resistant: up to 134 °C

	maximum instrument width	working length	
92-01477	up to 50 mm	140 mm	100 pieces
92-01471	up to 25 mm	105 mm	1000 pieces
92-01476	up to 10 mm	60 mm	1000 pieces

**Single use tip protectors, made of carton**

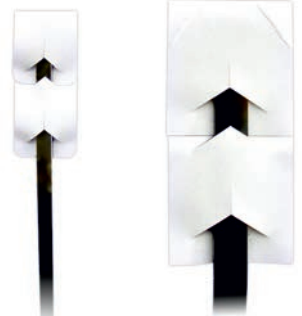

heat resistant: up to 134 °C

	maximum instrument width	working length	
92-01492	up to 50 mm	140 mm	100 pieces
92-01469	up to 25 mm	105 mm	1000 pieces
92-01470	up to 10 mm	60 mm	1000 pieces

**Single use tip protectors, made of carton**



The tip protector is already folded and glued. Suitable for: slender hooks, slitting knives, sickle knives and septum knives.

heat resistant: up to 134 °C

	maximum instrument width	working length	
92-01499	up to 20 mm	105 mm	100 pieces
92-01496	up to 20 mm	105 mm	1000 pieces



**Carton protective covers for amputation knives**

REF		pack. unit
	heat resistant: up to 134 °C	
92-01478	size: 246 x 33 mm with 16 holes	100 pieces
92-01479	size: 123 x 33 mm with 8 holes	100 pieces



**Instrument bundle strings made of silicone**

	Other dimensions on request!	
	heat resistant	
	sections of 30 cm	
92-09039	green	100 pieces
92-09143	blue	100 pieces
92-09144	yellow	100 pieces
92-09145	black	100 pieces
92-09146	red	100 pieces
92-09147	grey	100 pieces
92-09287	orange	100 pieces
92-09196	purple	100 pieces
	sections of 50 cm	
92-09139	green	100 pieces
92-09160	blue	100 pieces
92-09161	yellow	100 pieces
92-09162	black	100 pieces
92-09163	red	100 pieces
92-09164	grey	100 pieces
92-09288	orange	100 pieces
92-09197	purple	100 pieces
92-09709	white	100 pieces





**Cable binder made of silicone to bundle instruments**

	heat resistant: up to 134 °C	
	length: 110 mm	
92-09231	natural colour	100 pieces
92-09235	red	100 pieces
92-09236	yellow	100 pieces
92-09237	green	100 pieces
92-09238	blue	100 pieces
92-09369	violet	100 pieces
92-09370	black	100 pieces
	length: 210 mm	
92-09239	red	100 pieces
92-09240	yellow	100 pieces

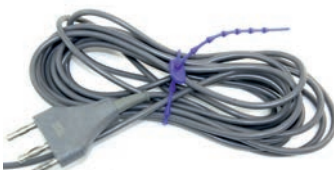

**Cable binder made of silicone to bundle instruments**

	REF		pack. unit
	92-09241	green	100 pieces
	92-09242	blue	100 pieces
	92-09371	violet	100 pieces
	92-09372	black	100 pieces
			

**Cable binder made of silicone to bundle instruments**

	REF		pack. unit
		heat resistant: up to 134 °C	
		length: 60 mm (mini)	
	92-09246	natural colour	100 pieces
	92-09252	green	100 pieces
	92-09253	blue	100 pieces
	92-09254	yellow	100 pieces
	92-09255	black	100 pieces
	92-09256	red	100 pieces
	92-09257	white	100 pieces
	92-09258	orange	100 pieces
	92-09259	brown	100 pieces
	92-09260	grey	100 pieces
	92-09261	violet	100 pieces
	92-09397	light blue	100 pieces
	92-09373	natural colour	100 pieces
	92-09374	red	100 pieces
	92-09375	yellow	100 pieces
	92-09376	green	100 pieces
	92-09377	blue	100 pieces
	92-09378	orange	100 pieces
	92-09379	black	100 pieces
	92-09282	natural colour	100 pieces
92-09283	red	100 pieces	
92-09284	green	100 pieces	
92-09285	blue	100 pieces	
92-09286	yellow	100 pieces	
92-09381	orange	100 pieces	
92-09382	black	100 pieces	



**Silicone boards**

REF		pack. unit
	Other sizes on request!	
	natural colour	
	thickness: 10 mm	
92-08624	size: 200 x 60 cm	1 piece
92-08668	size: 130 x 55 cm	1 piece
92-08335	size: 100 x 55 cm	1 piece
92-09191	size: 30 x 21 cm	1 piece
92-09189	size: 30 x 17 cm	1 piece
92-09192	size: 21 x 15 cm	1 piece
92-08669	size: 20 x 10 cm	1 piece
92-09190	size: 17 x 15 cm	1 piece
92-08375	size: 10 x 10 cm	1 piece
	thickness: 5 mm	
92-08675	size: 80 x 60 cm	1 piece
92-08719	size: 10 x 10 cm	1 piece
92-08674	size: 3.5 x 3.5 cm	1 piece

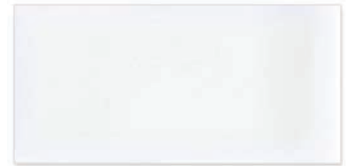

**Board made of synthetic material**

	prevents damages from blades, with rounded corners	
	clear, white	
	heat resistant	
	size: 24 x 19 cm	
92-09436	thickness: 3 mm	1 piece
92-09453	thickness: 10 mm	1 piece



**Silicone nub mats**

	flexible	
	heat resistant: from -40 °C to +300 °C	
	washable in washer-disinfector	
92-08321	blue, size: 500 x 320 mm	1 piece
92-08324	blue, size: 250 x 239 mm	1 piece
92-08757	grey, size: 500 x 320 mm	1 piece

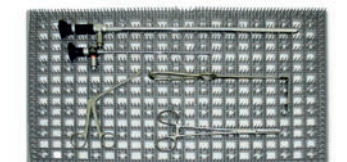
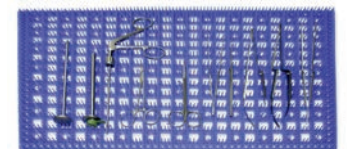

## Silicone nub mats

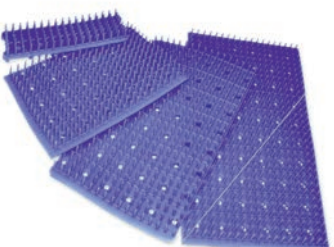
	REF		pack. unit
		blue heat resistant flexible washable in washer-disinfector	
	92-08426	size: 140 x 55 mm suitable for sterilization tray REF 92-08422	1 piece
	92-08427	size: 160 x 120 mm suitable for sterilization tray REF 92-08423	1 piece
	92-08428	size: 200 x 135 mm suitable for sterilization tray REF 92-08424	1 piece
	92-08322	size: 235 x 235 mm	1 piece
	92-08429	size: 250 x 155 mm suitable for sterilization tray REF 92-08425	1 piece

## Silicone nub mats

	92-08698	10 sections of 100 mm	1 piece
		pink heat resistant flexible size: 230 x 1000 mm washable in washer-disinfector	

## Silicone fence mat

	92-08600		1 piece
		blue flexible size: 540 x 320 mm heat resistant: from -60 °C to +300 °C washable in washer-disinfector	





Silicone mesh inserts for wire containers

REF		pack. unit
	grey heat resistant flexible washable in washer-disinfector	
92-08110	size: 600 x 324 mm, thickness: 6 mm	1 piece
92-08974	size: 540 x 280 mm, thickness: 3 mm	1 piece

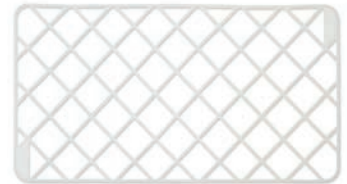

Silicone mesh inserts - "honeycomb structure" for perforated plate mesh tray

	dark blue flexible heat resistant: up to +230 °C washable in washer-disinfector	
92-08601	size: 480 x 250 mm	1 piece
92-08602	size: 238 x 248 mm	1 piece

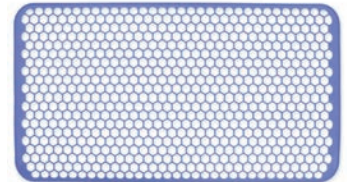

Silicone sheets for packing table, to protect instruments against damage

The silicone sheets are available in all sizes up to 300 cm (length) x 120 cm (width) in different colours. Thickness 2 mm. They protect your instruments effectively against damage, prevent against unpleasant cold- and dazzling effects of metallic surfaces. They can be cleaned with surface disinfection or in the washer-disinfector.

washable in washer-disinfector

ER860.240RB	redbrown	1 piece
ER860.240T	transparent	1 piece
ER860.240LG	leaf green	1 piece



Silicone tubes, translucent, tinted

	inner diameter	wall thickness	outer diameter	
92-09021	2.0 mm / red	1.0 mm	4.0 mm	25 m
92-09015	5.0 mm / green	1.5 mm	8.0 mm	25 m





**Silicone tubes, solid colour**

REF	inner diameter	wall thickness	outer diameter	pack. unit
 92-09135	3.0 mm / red	2.0 mm	7.0 mm	25 m
92-09154	3.0 mm / blue	2.0 mm	7.0 mm	25 m

**Silicone tubes, translucent, non-tinted**

REF	inner diameter	wall thickness	outer diameter	pack. unit
 92-09043	1.0 mm	0.3 mm	1.6 mm	25 m
92-09707	1.0 mm	2.0 mm	5.0 mm	25 m
92-09029	1.5 mm	0.5 mm	3.5 mm	25 m
92-09037	1.5 mm	0.75 mm	3.0 mm	25 m
92-09027	1.5 mm	1.0 mm	3.5 mm	25 m
92-09042	2.0 mm	0.5 mm	3.0 mm	25 m
92-09028	2.0 mm	0.75 mm	3.5 mm	25 m
92-09024	2.0 mm	1.0 mm	4.0 mm	25 m
92-09023	4.0 mm	1.0 mm	6.0 mm	25 m
92-09115	4.0 mm	1.5 mm	7.0 mm	25 m
92-09022	5.0 mm	1.0 mm	7.0 mm	25 m
92-09014	5.0 mm	2.0 mm	9.0 mm	25 m
92-09041	6.0 mm	3.0 mm	12.0 mm	25 m
92-09044	8.0 mm	2.0 mm	12.0 mm	25 m
92-09701	8.0 mm	2.0 mm	13.0 mm	25 m
92-09047	10.0 mm	1.5 mm	13.0 mm	25 m
92-09700	10.0 mm	2.5 mm	15.0 mm	25 m
92-09016	22.0 mm	2.0 mm	26.0 mm	25 m
92-09149	2,5 mm	1,5 mm	5,5 mm	25 m

**Silicone tubes with inner profile, translucent, non-tinted**

REF	inner diameter	wall thickness	outer diameter	pack. unit
 92-09706	6 webs / 0.5 mm 2.5 mm	0.5 mm	3.5 mm	25 m
92-09183	2.5 mm	1.2 mm	4.9 mm	25 m
 92-09233	6 webs / 1 mm 4.0 mm	0.5 mm	5.0 mm	25 m
92-09150	4.0 mm	1.2 mm	6.4 mm	25 m
92-09151	6.0 mm	1.2 mm	8.4 mm	25 m
92-09152	8 webs / 1 mm 8.0 mm	1.2 mm	10.4 mm	25 m
92-09142	10.6 mm	1.2 mm	13.0 mm	25 m
92-09153	12.0 mm	1.2 mm	14.4 mm	25 m
92-09705	16 webs / 1 mm 20.0 mm	1.0 mm	22.0 mm	25 m



**Silicone tubes with inner profile, translucent, tinted, green**

REF	inner diameter	wall thickness	outer diameter	pack. unit
92-09710	6 webs / 0.5 mm 2.5 mm	0.5 mm	3.5 mm	25 m
92-09711	6 webs / 1 mm 4.0 mm	0.5 mm	5.0 mm	25 m
92-09712	6 webs / 1 mm 6.0 mm	1.2 mm	8.4 mm	25 m
92-09713	8 webs / 1 mm 8.0 mm	1.2 mm	10.4 mm	25 m



**Measuring gauge for tubes**

92-09703	for measuring inner- and outer diameters of tubes	1 piece
----------	---	---------



**Scissors to cut tubes**

92-09060	length: 160 mm, blade and spring made of stainless steel, scissors made of plastic, lockable, easy to clean  white heat resistant: up to 134 °C washable in washer-disinfector	1 piece
----------	--	---------



**Scissors to cut tubes**

92-08510	Easy usage and secure cutting due to half-rounded overlay, teflon-plated blade, scissors made of plastic, easy cutting up to 1-inch tube-thickness  heat resistant: up to 134 °C washable in washer-disinfector	1 piece
----------	--	---------



**Tyvek pouches - flat**

REF

pack. unit



Tyvek packaging for low temperature sterilization

- sterilizable with: H<sub>2</sub>O<sub>2</sub> (plasma), EO, FO and Gamma
- the seal seams are extremely strong and durable
- with peelable seal seams
- extra strong materials for superior tear strength and puncture resistance
- excellent barrier properties
- made of Tyvek and multilayer film

with H<sub>2</sub>O<sub>2</sub> indicator

92-36212	size: 75 x 200 mm	1000 pieces
92-36213	size: 100 x 250 mm	1000 pieces
92-36235	size: 100 x 400 mm	1000 pieces
92-36214	size: 150 x 300 mm	1000 pieces
92-36215	size: 160 x 440 mm	1000 pieces
92-36216	size: 160 x 600 mm	1000 pieces
92-36217	size: 200 x 380 mm	500 pieces
92-36218	size: 250 x 380 mm	500 pieces
92-36219	size: 250 x 500 mm	500 pieces

**Tyvek pouches - self-adhesive**



Tyvek packaging for low temperature sterilization

- sterilizable with: H<sub>2</sub>O<sub>2</sub> (plasma), EO, FO and Gamma
- the seal seams are extremely strong and durable
- with peelable seal seams
- extra strong materials for superior tear strength and puncture resistance
- excellent barrier properties
- made of Tyvek and multilayer film

with H<sub>2</sub>O<sub>2</sub> indicator

92-36220	size: 90 x 200 mm	1000 pieces
92-36221	size: 90 x 250 mm	1000 pieces
92-36222	size: 130 x 270 mm	1000 pieces
92-36223	size: 130 x 380 mm	1000 pieces
92-36224	size: 200 x 350 mm	1000 pieces
92-36234	size: 190 x 330 mm	1000 pieces
92-36225	size: 250 x 400 mm	600 pieces
92-36226	size: 300 x 450 mm	600 pieces

**Tyvek reels - flat**

REF		pack. unit
92-36227	size: 75 mm x 100 m	1 reel
92-36228	size: 100 mm x 100 m	1 reel
92-36229	size: 150 mm x 100 m	1 reel
92-36230	size: 200 mm x 100 m	1 reel
92-36231	size: 225 mm x 100 m	1 reel
92-36232	size: 250 mm x 100 m	1 reel
92-36233	size: 300 mm x 100 m	1 reel
92-36237	size: 400 mm x 100 m	1 reel
92-36238	size: 500 mm x 100 m	1 reel

**Tubular film for hot air sterilization**

	film thickness: 0.03 mm	
	reel length: 100 m	
92-36201	reel width: 30 mm	1 reel
92-36202	reel width: 50 mm	1 reel
92-36203	reel width: 75 mm	1 reel
92-36204	reel width: 100 mm	1 reel
92-36205	reel width: 150 mm	1 reel
92-36206	reel width: 200 mm	1 reel
92-36207	reel width: 250 mm	1 reel
92-36208	reel width: 300 mm	1 reel
	reel length: 80 m	
92-36209	reel width: 450 mm	1 reel

**Flat pouches for hot air sterilization**

	film thickness: 0.036 mm	
92-36210	size: 80 x 160 mm	500 pieces
92-36211	size: 120 x 200 mm	500 pieces

**LDPE dustproof bag, clean-room quality**

	secondary packaging	
	film thickness: 50 µ	
92-09916	size: 70 x 700 mm	250 pieces
92-09922	size: 70 x 1000 mm	20 pieces
92-09923	size: 70 x 1000 mm	250 pieces

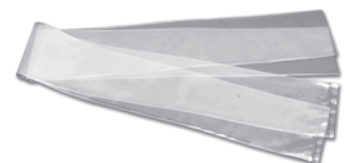

**LDPE dustproof bag**

	REF		pack. unit
	92-09924	opaque, brown coloured size: 200 x 400 mm material width: 80 µ	1000 pieces

**Dustproof bags, without imprint**

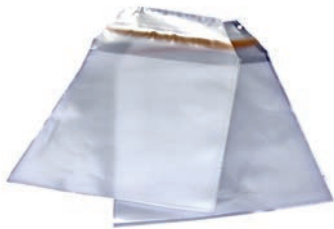
		LDPE bag, not suitable for sterilization, transparent, unprinted, robust design with flap and adhesive seal for protection and packing of sterilized instruments, suitable to store disinfected anaesthetic equipment	
		transparent	
		sterilizable: no	
	92-03004	size: 100 x 150 mm, 50 µ	500 pieces
	92-03024	size: 100 x 350 mm, 50 µ	100 pieces
	92-03026	size: 120 x 520 mm, 50 µ	100 pieces
	92-03023	size: 150 x 270 mm, 50 µ	100 pieces
	92-03025	size: 150 x 380 mm, 50 µ	100 pieces
	92-03029	size: 200 x 300 mm, 50 µ	100 pieces
	92-03028	size: 300 x 650 mm, 80 µ	100 pieces
	92-03007	size: 300 x 400 mm, 60 µ	100 pieces
	92-03030	size: 300 x 500 mm, 50 µ	100 pieces
	92-03031	size: 420 x 700 mm, 50 µ	100 pieces
	92-03022	size: 450 x 480 mm, 30 µ	100 pieces
	92-03032	size: 600 x 750 mm, 50 µ	100 pieces
92-03037	size: 630 x 820 mm, 60 µ	100 pieces	
92-03049	size: 700 x 1050 mm, 70 µ	50 pieces	

**Dustproof bags, with imprint of application range**

		LDPE bag, not suitable for sterilization, transparent, robust design with flap and adhesive sea. Imprint: Staubschutzhüllen selbstklebend - Nicht sterilisierbar! Als Lagerschutz nach der Sterilisation / Self Seal Dust Cover - Do not sterilize! For pack protection after sterilization / Buste di protezione autosigillanti - Non sterilizzabili! Protezione delle confezioni dopo la sterilizzazione / Sachets de protection auto-adhésifs - Non stérilisables! Pour la protection des packs après la stérilisation	
		sterilizable: no	
	92-03033	size: 245 x 345 mm, 60 µ	100 pieces
	92-03036	size: 300 x 600 mm, 60 µ	100 pieces



### Dustproof bags, with imprint of application range

REF		pack. unit
92-03017	size: 400 x 600 mm, 50 µ	100 pieces
92-03035	size: 460 x 750 mm, 60 µ	100 pieces
92-03040	size: 500 x 500 mm, 60 µ	100 pieces
92-03034	size: 640 x 770 mm, 60 µ	100 pieces



### Dustproof bag with slider zipper

LDPE bag, not suitable for sterilization,  
transparent, unprinted, robust design, reclosable

transparent  
sterilizable: no

92-03044	size: 170 x 120 mm, 60 µ	100 pieces
92-03043	size: 200 x 150 mm, 60 µ	100 pieces
92-03041	size: 320 x 230 mm, 75 µ	100 pieces
92-03045	size: 320 x 440 mm, 70 µ	100 pieces
92-03046	size: 480 x 640 mm, 70 µ	50 pieces



### Microsnap Bags

LDPE bag, not suitable for sterilization,  
transparent, unprinted, robust design, reclosable

transparent  
sterilizable: no  
material width: 50 µ

92-09908	size: 80 x 120 mm	2000 pieces
92-09912	size: 70 x 100 mm	1000 pieces
92-09902	size: 80 x 120 mm	1000 pieces
92-09917	size: 90 x 450 mm	1000 pieces
92-09918	size: 90 x 550 mm	1000 pieces
92-09919	size: 90 x 670 mm	1000 pieces
92-09906	size: 100 x 150 mm	1000 pieces



**Microsnap Bags**

	REF		pack. unit
	92-09903	size: 150 x 220 mm	1000 pieces
	92-09914	size: 180 x 250 mm	1000 pieces
	92-09900	size: 220 x 300 mm	1000 pieces
	92-09997	size: 250 x 350 mm	1000 pieces
	92-09905	size: 300 x 400 mm	1000 pieces
	92-09911	size: 400 x 500 mm	500 pieces
	92-09909	size: 400 x 600 mm	500 pieces
	92-09910	size: 500 x 600 mm	500 pieces
	92-09913	size: 120 x 170 mm	1000 pieces

**Security labels, green, single self adhesive**

	92-04281	After approximately 15 minutes the security effect of the glue will occur.	1 reel
		with imprint: "Sicherheitssiegel / Security Seal" size: 90 x 30 mm numbering: serially reel width: 102 mm pieces per reel: 500 pieces dispensed on the inside core diameter: 76 mm	

**LDPE cover for trolleys**

	92-03060	bundled to 20 pcs.	140 pieces
		transparent size: 700/620 x 1600 mm	





**C-bow cover for x-ray machines**

REF		pack. unit
92-03053	20 pcs. / dispenser  size: 235 x 104 cm single packed, sterile	1 carton



**Hoods set for endoscope-trays, non-sterile**

92-03056	<p>Set consisting of:</p> <ul style="list-style-type: none"> <li>• 1 LDPE-hood, turnable, transparent, with elastic band, size: 600 x 700 x 0.030 mm, both-sided imprint: 1. side green "dekontaminiert/decontaminated" / 2. side red "kontaminiert/contaminated"</li> <li>• 1 HDPE- insertion bag in hexagon shape, size: 380 x 890 x 0,040 mm, without imprint</li> </ul>	1 set
----------	---	-------

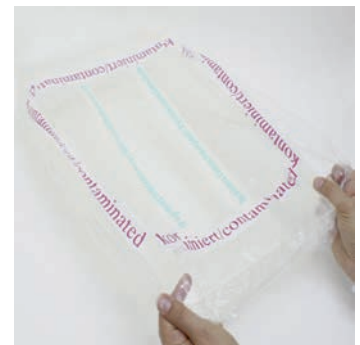

**Endo Seal Bag, latex free**

92-26010	<p>sterile endoscope storage and transport bag with flap and two adhesive strips, simple identification of the content:</p> <ul style="list-style-type: none"> <li>• green side: cleaned</li> <li>• red side: contaminated</li> </ul> <p>green/red flap: 640 x 150 mm size: 640 x 540 mm sterile packing for single use</p>	250 pieces
----------	---	------------



**Single labels on reel, blank, 38 x 98 mm**

REF		pack. unit
		
	without indicator reel width: 40 mm pieces per reel: 500 pieces dispensed on the outside single self-adhesive	
92-04257	core diameter: 25 mm	1 reel
92-04261	heat resistant: up to 134 °C core diameter: 25 mm, thermografic paper, autoclave-resistant: no	1 reel



**Single labels on reel, blank, 50 x 33 mm**

		
	without indicator reel width: 53 mm pieces per reel: 1000 pieces dispensed on the outside heat resistant: up to 134 °C double self-adhesive	
92-04138	core diameter: 76 mm	1 reel
92-04208	core diameter: 40 mm	1 reel



**Single labels on reel, blank, 51 x 35 mm**

		
92-04264	without indicator core diameter: 76 mm reel width: 53 mm pieces per reel: 4000 pieces dispensed on the outside heat resistant: up to 134 °C single self-adhesive	1 reel

**Single labels on reel, blank, one-side tear-off tag , blank, 55 x 35 mm**

REF		pack. unit	
92-04189	without indicator glue: removable core diameter: 50 mm reel width: 59 mm pieces per reel: 1000 pieces dispensed on the outside heat resistant: up to 134 °C single self-adhesive	1 reel	 



**Single labels on reel, blank, 58 x 35 mm**

	without indicator core diameter: 40 mm reel width: 61 mm pieces per reel: 1000 pieces dispensed on the outside heat resistant: up to 134 °C single self-adhesive		 
92-04224	without tear-off perforation	1 reel	
92-04270	with tear-off perforation	1 reel	

**Single labels on reel, blank, 60 x 34 mm**

92-04087	without indicator core diameter: 25 mm with tear-off perforation reel width: 67 mm pieces per reel: 900 pieces dispensed on the outside heat resistant: up to 134 °C double self-adhesive	1 reel	 
----------	--	--------	---

**Single labels on reel, blank, extra strong glue, 60 x 34 mm**

92-04152	without indicator core diameter: 40 mm with tear-off perforation reel width: 63 mm pieces per reel: 1000 pieces dispensed on the outside heat resistant: up to 134 °C double self-adhesive	1 reel	 
----------	---	--------	---

**Single labels on reel, blank, 63 x 40 mm**

	REF		pack. unit
	92-04161	without indicator core diameter: 76 mm reel width: 67 mm pieces per reel: 2000 pieces dispensed on the outside heat resistant: up to 134 °C double self-adhesive	1 reel

**Single labels on reel, blank, 70 x 33 mm**

		without indicator size: 70 x 33 mm with tear-off perforation reel width: 73 mm pieces per reel: 1000 pieces dispensed on the outside double self-adhesive	
	92-04027	core diameter: 76 mm	1 reel
	92-04084	core diameter: 40 mm	1 reel



**Single labels on reel, blank, 72 x 48 mm**

	92-04292	without indicator upper material with slit core diameter: 76 mm pieces per reel: 660 pieces dispensed on the outside double self-adhesive	1 reel
---	----------	--	--------

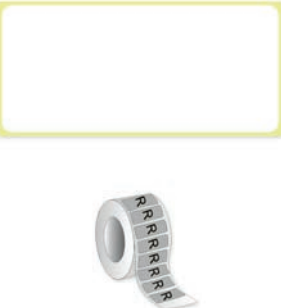

**Single labels on reel, blank, without slit, 75 x 35 mm**

	92-04284	without indicator core diameter: 76 mm without tear-off perforation reel width: 78 mm pieces per reel: 2000 pieces dispensed on the outside heat resistant: up to 134 °C double self-adhesive	1 reel
---	----------	--	--------



**Single labels on reel, blank, 75 x 35 mm**

REF		pack. unit	
	without indicator core diameter: 76 mm reel width: 78 mm pieces per reel: 2000 pieces dispensed on the outside heat resistant: up to 134 °C		
92-04146	without tear-off perforation, single self-adhesive	1 reel	
92-04188	with tear-off perforation, double self-adhesive	1 reel	



**Single labels on reel, blank, 95 x 60 mm**

92-04263	without indicator core diameter: 40 mm reel width: 98 mm pieces per reel: 2500 pieces dispensed on the outside heat resistant: up to 134 °C single self-adhesive	1 reel	
			

**Single labels on reel, blank, 102 x 56 mm**

92-04187	without indicator (divided into 3 labels: 1 of 102 x 34 mm and 2 of 51 x 22 mm) core diameter: 76 mm with tear-off perforation reel width: 106 mm pieces per reel: 2000 pieces dispensed on the outside heat resistant: up to 134 °C double self-adhesive	1 reel	
			

**Single labels on reel, blank, 105 x 33 mm**

92-04078	without indicator glue: removable core diameter: 40 mm with tear-off perforation reel width: 110 mm pieces per reel: 1000 pieces dispensed on the inside heat resistant: up to 134 °C single self-adhesive	1 reel	
			

**Single labels on reel, blank, 110 x 60 mm**  
REF

pack. unit



92-04092

without indicator  
core diameter: 40 mm  
with tear-off perforation  
reel width: 113 mm  
pieces per reel: 1000 pieces  
dispensed on the outside  
heat resistant: up to 134 °C  
single self-adhesive

1 reel

**Single labels on reel, blank, 110 x 80 mm**



92-04140

without indicator  
core diameter: 40 mm  
with tear-off perforation  
reel width: 113 mm  
pieces per reel: 1000 pieces  
dispensed on the outside  
heat resistant: up to 134 °C  
single self-adhesive

1 reel

**Foil labels on reel, blank, 32 x 22 mm**

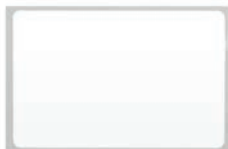

92-04173

glue: strong adhesive  
core diameter: 40 mm  
without tear-off perforation  
reel width: 36 mm  
pieces per reel: 1000 pieces  
dispensed on the outside  
heat resistant: up to 134 °C  
washable in washer-disinfector  
single self-adhesive

1 reel

**Foil labels on reel, blank, 40 x 28 mm**





92-04218  
92-04174

glue: strong adhesive  
with tear-off perforation  
reel width: 44 mm  
pieces per reel: 1000 pieces  
dispensed on the outside  
heat resistant: up to 134 °C  
washable in washer-disinfector  
single self-adhesive



core diameter: 25 mm  
core diameter: 40 mm

1 reel  
1 reel



**Foil labels on reel, blank, 50 x 23 mm**

REF		pack. unit	
	glue: strong adhesive with tear-off perforation reel width: 54 mm pieces per reel: 1000 pieces dispensed on the outside heat resistant: up to 134 °C washable in washer-disinfector single self-adhesive		 
92-04227	core diameter: 40 mm	1 reel	
92-04271	core diameter: 25 mm	1 reel	



**Foil labels on reel, blank, 54 x 16 mm**

92-04239	glue: strong adhesive core diameter: 40 mm with tear-off perforation reel width: 54 mm pieces per reel: 1000 pieces dispensed on the outside heat resistant: up to 134 °C washable in washer-disinfector single self-adhesive	1 reel	 
----------	---	--------	---

**Foil labels on reel, blank, 55 x 35 mm**

92-04186	glue: removable one-side tear-off tag core diameter: 50 mm with tear-off perforation reel width: 59 mm pieces per reel: 1000 pieces dispensed on the outside heat resistant: up to 134 °C washable in washer-disinfector single self-adhesive	1 reel	 
----------	--	--------	--

**Foil labels on reel, blank, 60 x 25 mm**

	glue: strong adhesive with tear-off perforation reel width: 64 mm pieces per reel: 1000 pieces dispensed on the outside heat resistant: up to 134 °C washable in washer-disinfector single self-adhesive		 
92-04176	core diameter: 40 mm	1 reel	
92-04293	white, without indicator, core diameter: 76 mm	1 reel	

**Foil labels on reel, coloured, 60 x 25 mm**

REF

pack. unit



glue: strong adhesive  
 core diameter: 40 mm  
 with tear-off perforation  
 reel width: 64 mm  
 pieces per reel: 1000 pieces  
 dispensed on the outside  
 heat resistant: up to 134 °C  
 washable in washer-disinfector  
 single self-adhesive

92-04221	red	1 reel
92-04222	green	1 reel
92-04223	blue	1 reel
92-04255	yellow	1 reel

**Foil labels on reel, blank, 70 x 33 mm**

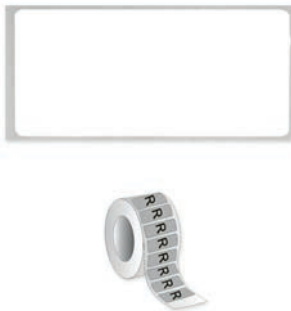

glue: strong adhesive  
 reel width: 74 mm  
 pieces per reel: 1000 pieces  
 dispensed on the outside  
 heat resistant: up to 134 °C  
 washable in washer-disinfector  
 single self-adhesive

92-04175	core diameter: 40 mm, with tear-off perforation	1 reel
92-04139	core diameter: 25 mm, without tear-off perforation	1 reel

**Single labels on reel with steam indicator, 40 x 43 mm**



92-04088	core diameter: 50 mm with tear-off perforation reel width: 47 mm pieces per reel: 750 pieces dispensed on the outside colour change: from pink to brown double self-adhesive	1 reel
----------	--	--------



**Single labels on reel with steam indicator, 50 x 33 mm**





92-04207	imprint: with reference to the norm and the colour change core diameter: 40 mm with tear-off perforation reel width: 53 mm pieces per reel: 1000 pieces dispensed on the outside colour change: from pink to brown suitable for: non-woven materials double self-adhesive	1 reel
----------	---	--------

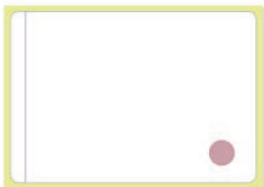

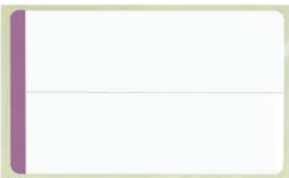

**Single labels on reel with steam indicator, 57 x 40 mm**

REF		pack. unit	
92-04141	core diameter: 40 mm reel width: 60 mm pieces per reel: 1000 pieces dispensed on the outside colour change: from pink to brown double self-adhesive	1 reel	 

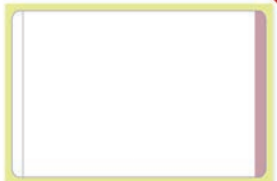

**Single labels on reel with steam indicator, 58.5 x 35 mm**

92-04209	upper material with horizontal slit size: 58.5 x 35 mm core diameter: 40 mm with tear-off perforation reel width: 62 mm pieces per reel: 1000 pieces dispensed on the outside colour change: from pink to brown double self-adhesive	1 reel	 
----------	--	--------	---



**Single labels on reel with steam indicator, 58 x 38 mm**

92-04290	core diameter: 40 mm with tear-off perforation pieces per reel: 1000 pieces dispensed on the outside colour change: from pink to brown double self-adhesive	1 reel	 
----------	--	--------	--

**Single labels on reel, with steam indicator, 58.5 x 35 mm**

92-04214	core diameter: 40 mm with tear-off perforation pieces per reel: 1000 pieces dispensed on the outside colour change: from pink to brown double self-adhesive	1 reel	 
----------	--	--------	--

**Single labels on reel with steam indicator, 60 x 31 mm, 2000 pieces per reel**

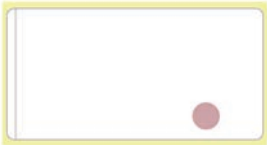

REF		pack. unit
92-04094	 <p>core diameter: 40 mm with tear-off perforation reel width: 64 mm dispensed on the inside colour change: from pink to brown suitable for: non-woven materials double self-adhesive</p> 	1 reel

**Single labels on reel with steam indicator, 60 x 31 mm, 1000 pieces per reel**

	 <p>with tear-off perforation reel width: 64 mm colour change: from pink to brown double self-adhesive</p>	
92-04190	core diameter: 40 mm, dispensed on the inside	1 reel
92-04160	core diameter: 25 mm, dispensed on the outside	1 reel

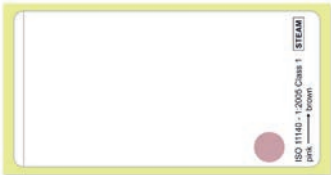

**Single labels on reel with steam indicator and reference, 60 x 31 mm**



92-04028	 <p>imprint: with reference to the norm and the colour change core diameter: 40 mm with tear-off perforation reel width: 64 mm dispensed on the inside pieces per reel: 1000 pieces colour change: from pink to brown suitable for: non-woven materials</p> 	1 reel
----------	--	--------

**Single labels on reel with steam indicator, 60 x 33 mm**



	 <p>with tear-off perforation reel width: 63 mm dispensed on the outside colour change: from pink to brown double self-adhesive</p>	
92-04300	core diameter: 76 mm, pieces per reel: 1000 pieces	1 reel
92-04086	core diameter: 40 mm, pieces per reel: 1000 pieces	1 reel
92-04158	core diameter: 40 mm, pieces per reel: 2000 pieces	1 reel



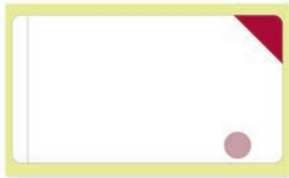

**Single labels on reel with steam indicator, 60 x 33 mm**

REF		pack. unit	
	core diameter: 40 mm with tear-off perforation reel width: 63 mm dispensed on the inside colour change: from pink to brown		
92-04265	pieces per reel: 1000 pieces, double self-adhesive	1 reel	
92-04266	pieces per reel: 2000 pieces, double self-adhesive	1 reel	
92-04199	pieces per reel: 2000 pieces, single self-adhesive	1 reel	



**Single labels on reel with red corner, with steam indicator, 60 x 33 mm**

92-04010	core diameter: 40 mm reel width: 64 mm pieces per reel: 1000 pieces dispensed on the outside colour change: from pink to brown double self-adhesive	1 reel	 
----------	--	--------	---



**Single labels on reel, coloured with steam indicator, 60 x 33 mm**

	core diameter: 40 mm with tear-off perforation reel width: 64 mm pieces per reel: 1000 pieces dispensed on the outside colour change: from pink to brown double self-adhesive		
92-04243	blue	1 reel	
92-04244	green	1 reel	
92-04245	red	1 reel	
92-04246	yellow	1 reel	



**Single labels on reel with steam indicator, 63 x 40 mm**

	reel width: 67 mm colour change: from pink to brown suitable for: non-woven materials double self-adhesive		
92-04282	core diameter: 76 mm pieces per reel: 1000 pieces dispensed on the inside	1 reel	
92-04038	core diameter: 40 mm pieces per reel: 2000 pieces dispensed on the inside	1 reel	
92-04090	core diameter: 40 mm pieces per reel: 1000 pieces dispensed on the inside	1 reel	



**Single labels on reel with steam indicator, 63 x 40 mm**

	REF		pack. unit
	92-04057	core diameter: 76 mm pieces per reel: 2000 pieces dispensed on the outside	1 reel
			

**Single labels on reel with steam indicator, 70 x 33 mm**

		with tear-off perforation reel width: 73 mm pieces per reel: 2000 pieces dispensed on the outside colour change: from pink to brown suitable for: non-woven materials double self-adhesive	
	92-04144	core diameter: 40 mm	1 reel
	92-04169	core diameter: 76 mm	1 reel

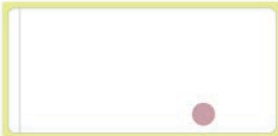
**Single labels on reel with steam indicator, 70 x 33 mm**

	92-04147	core diameter: 76 mm with tear-off perforation reel width: 73 mm pieces per reel: 2000 pieces dispensed on the inside colour change: from pink to brown suitable for: non-woven materials double self-adhesive	1 reel
			

**Single labels on reel with steam indicator, 70 x 33 mm**

		with tear-off perforation reel width: 73 mm pieces per reel: 1000 pieces colour change: from pink to brown suitable for: non-woven materials double self-adhesive	
	92-04295	core diameter: 76 mm dispensed on the outside	1 reel
	92-04089	core diameter: 76 mm dispensed on the outside	1 reel
	92-04306	with steam indicator on the left side core diameter: 40 mm dispensed on the inside	1 reel

**Single labels on reel with steam indicator, 70 x 33 mm**

REF		pack. unit	
92-04301	imprint: with reference to the norm and the colour change core diameter: 40 mm with tear-off perforation pieces per reel: 1000 pieces dispensed on the outside colour change: from pink to brown suitable for: non-woven materials double self-adhesive	1 reel	

**Single labels on reel with steam indicator, 70 x 35 mm**

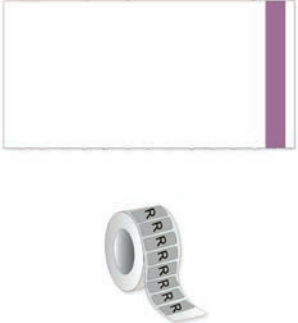
92-04037	with slit on the back core diameter: 40 mm with tear-off perforation reel width: 70 mm pieces per reel: 1250 pieces dispensed on the outside colour change: from pink to brown single self-adhesive	1 reel	
----------	--	--------	--



**Single labels on reel with steam indicator, 70 x 35 mm**

92-04178	imprint: with reference to the norm and the colour change core diameter: 40 mm with tear-off perforation reel width: 73 mm pieces per reel: 1000 pieces dispensed on the outside colour change: from pink to brown suitable for: non-woven materials single self-adhesive	1 reel	
----------	---	--------	---

**Single labels on reel with steam indicator, 70 x 35 mm**

92-04157	core diameter: 40 mm with tear-off perforation reel width: 73 mm pieces per reel: 2500 pieces dispensed on the inside colour change: from pink to brown suitable for: non-woven materials double self-adhesive	1 reel	
----------	---	--------	---



**Single labels on reel with steam indicator, 70 x 35 mm**

REF		pack. unit
92-04180	  <p>core diameter: 40 mm with tear-off perforation reel width: 73 mm pieces per reel: 2500 pieces dispensed on the outside colour change: from pink to brown suitable for: non-woven materials double self-adhesive</p>	1 reel



**Single labels on reel with steam indicator, 70 x 35 mm**

	 <p>core diameter: 40 mm with tear-off perforation reel width: 73 mm dispensed on the outside colour change: from pink to brown suitable for: non-woven materials double self-adhesive</p>	
92-04197	pieces per reel: 2000 pieces	1 reel
92-04262	pieces per reel: 1000 pieces	1 reel



**Single labels on reel with steam indicator, 70 x 35 mm**

	  <p>with tear-off perforation reel width: 73 mm pieces per reel: 1000 pieces colour change: from pink to brown suitable for: non-woven materials double self-adhesive</p>	
92-04182	with steam indicator on the left side core diameter: 40 mm dispensed on the outside	1 reel
92-04183	with steam indicator on the right side core diameter: 40 mm dispensed on the outside	1 reel
92-04256	with steam indicator on the left side core diameter: 76 mm dispensed on the inside	1 reel
92-04272	with steam indicator on the left side core diameter: 76 mm dispensed on the outside	1 reel



**Single labels on reel with steam indicator and reference, 70 x 35 mm**

REF		pack. unit	
	imprint: with reference to the norm and the colour change with tear-off perforation reel width: 73 mm colour change: from pink to brown suitable for: non-woven materials double self-adhesive		
92-04198	core diameter: 40 mm pieces per reel: 1000 pieces dispensed on the inside	1 reel	
92-04236	core diameter: 40 mm pieces per reel: 2500 pieces dispensed on the inside	1 reel	
92-04250	core diameter: 40 mm pieces per reel: 1000 pieces dispensed on the outside	1 reel	
92-04242	core diameter: 76 mm pieces per reel: 1000 pieces dispensed on the outside	1 reel	
92-04302	core diameter: 76 mm pieces per reel: 1000 pieces dispensed on the inside	1 reel	

**Single labels on reel with steam indicator and reference, extra powerful adhesive, 70 x 35 mm**

	imprint: with reference to the norm and the colour change with tear-off perforation reel width: 73 mm pieces per reel: 1000 pieces dispensed on the outside colour change: from pink to brown suitable for: Kimberly Clark non woven materials double self-adhesive		
92-04226	core diameter: 40 mm	1 reel	
92-04249	core diameter: 76 mm	1 reel	

**Single labels on reel with steam indicator, with colour bars, 70 x 35 mm**

	imprint: with reference to the norm and the colour change core diameter: 76 mm with tear-off perforation reel width: 73 mm pieces per reel: 1000 pieces dispensed on the outside colour change: from pink to brown suitable for: non-woven materials double self-adhesive		
92-04273	red	1 reel	
92-04274	blue	1 reel	
92-04275	green	1 reel	
92-04276	yellow	1 reel	

**Single labels on reel with steam indicator and reference, coloured, 70 x 35 mm**

	REF		pack. unit
		imprint: with reference to the norm and the colour change core diameter: 40 mm with tear-off perforation pieces per reel: 1000 pieces dispensed on the outside colour change: from pink to brown double self-adhesive	
	92-04251	blue	1 reel
	92-04252	green	1 reel
	92-04253	red	1 reel
	92-04254	yellow	1 reel

**Single labels on reel with steam indicator, 70 x 36.8 mm**

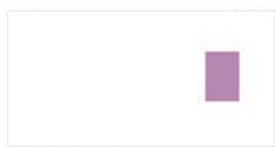

92-04055	with slit on the back core diameter: 40 mm with tear-off perforation pieces per reel: 2500 pieces dispensed on the outside colour change: from pink to brown single self-adhesive	1 reel
----------	---	--------

**Single labels on reel with steam indicator, 70 x 38 mm**



	core diameter: 76 mm with tear-off perforation reel width: 73 mm pieces per reel: 750 pieces dispensed on the inside colour change: from pink to brown double self-adhesive	
92-04127	suitable for: crepe paper	1 reel
92-04133	suitable for: non-woven materials and extended heat-impact	1 reel

**Single labels on reel with steam indicator, 70 x 38.1 mm**

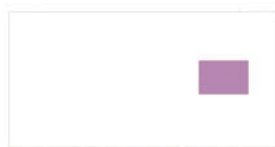

92-04036	with slit on the back core diameter: 40 mm with tear-off perforation pieces per reel: 2500 pieces dispensed on the outside colour change: from pink to brown single self-adhesive	1 reel
----------	---	--------



**Single labels on reel with coloured corner, with steam indicator, 70 x 39 mm**

REF		pack. unit
	imprint: with reference to the colour change core diameter: 76 mm reel width: 74 mm pieces per reel: 2000 pieces dispensed on the inside colour change: from pink to brown double self-adhesive	
92-04075	red	1 reel
92-04074	blue	1 reel
92-04076	green	1 reel
92-04077	yellow	1 reel

**Single labels on reel with steam indicator, 72 x 48 mm**

	imprint: with reference slit: upper material with slit with tear-off perforation pieces per reel: 660 pieces dispensed on the outside colour change: from pink to brown double self-adhesive	
92-04167	core diameter: 40 mm	1 reel
92-04287	core diameter: 76 mm	1 reel

**Single labels on reel with steam indicator, 75 x 35 mm**

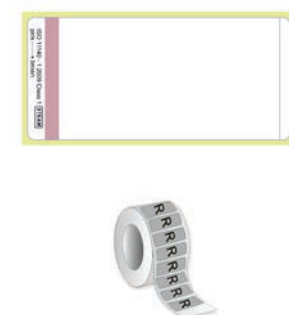

92-04280	imprint: with reference to the norm and the colour change core diameter: 76 mm with tear-off perforation pieces per reel: 1000 pieces dispensed on the outside colour change: from pink to brown suitable for: non-woven materials double self-adhesive	1 reel
----------	--	--------

**Labels for Webeco on reel, central perforation, 88.5 x 36 mm**

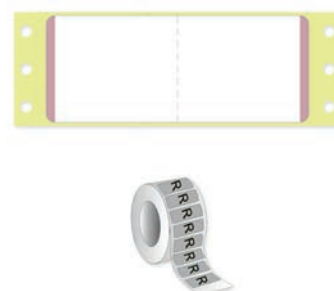

92-04066	with steam indicator slit: with slit on the back core diameter: 40 mm with tear-off perforation reel width: 110 mm pieces per reel: 1000 pieces dispensed on the outside colour change: from pink to brown single self-adhesive	1 reel
----------	---	--------

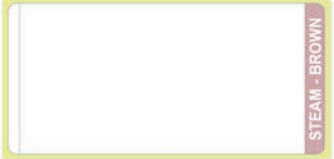



**Single labels on reel with steam indicator, 83 x 40 mm**

	REF		pack. unit
 	92-04241	with tear-off perforation reel width: 87 mm pieces per reel: 1000 pieces dispensed on the outside colour change: from pink to brown suitable for: non-woven materials double self-adhesive	1 reel
	92-04291	core diameter: 76 mm core diameter: 40 mm	1 reel



**Single labels on reel with steam indicator, 90 x 35 mm**

 	92-04296	imprint: with documentation field and reference to the norm and the colour change with tear-off perforation pieces per reel: 2000 pieces dispensed on the inside colour change: from pink to brown suitable for: non-woven materials double self-adhesive	1 reel
	92-04299	core diameter: 40 mm core diameter: 76 mm	1 reel

**Single labels on reel with red corner, with steam indicator, 90 x 35 mm**

 	92-04021	imprint: with reference to the norm and the colour change reel width: 94 mm dispensed on the inside colour change: from pink to brown suitable for: non-woven materials double self-adhesive	1 reel
	92-04303	core diameter: 76 mm pieces per reel: 2000 pieces core diameter: 40 mm pieces per reel: 1000 pieces	1 reel

**Single labels on reel with steam indicator, 100 x 70 mm**

 	92-04286	imprint: with reference to the norm and the colour change core diameter: 76 mm reel width: 103 mm pieces per reel: 1000 pieces dispensed on the outside colour change: from pink to brown single self-adhesive	1 reel
--	----------	--	--------

**Single labels on reel with steam indicator, 100 x 75 mm**

REF

pack. unit

92-04171      imprint: with reference to the colour change  
 (divided into 3 labels: 1 of 100 x 50 mm and 2 of 50  
 x 25 mm)  
 core diameter: 25 mm  
 reel width: 104 mm  
 pieces per reel: 500 pieces  
 dispensed on the outside  
 colour change: from pink to brown  
 double self-adhesive

1 reel

**Single labels on reel with steam indicator, 102 x 56 mm**

92-04137      imprint: with reference to the colour change  
 (divided into 3 labels of 56 x 34 mm)  
 core diameter: 76 mm  
 reel width: 105 mm  
 pieces per reel: 2000 pieces  
 dispensed on the outside  
 colour change: from pink to brown  
 double self-adhesive

1 reel

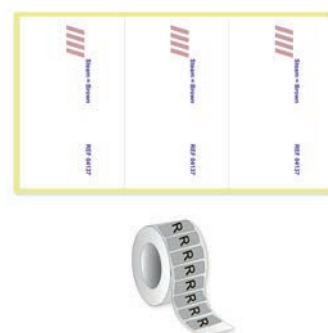
**Single labels on reel with steam indicator, 102 x 56 mm**

imprint: with reference to the colour change  
 (divided into 3 labels: 1 of 102 x 34 mm and 2 of 51  
 x 22 mm)  
 reel width: 106 mm  
 colour change: from pink to brown  
 double self-adhesive

92-04150      core diameter: 76 mm  
 pieces per reel: 2000 pieces  
 dispensed on the outside

1 reel



92-04164      core diameter: 25 mm  
 pieces per reel: 660 pieces  
 dispensed on the outside

1 reel



92-04165      core diameter: 40 mm  
 pieces per reel: 660 pieces  
 dispensed on the inside

1 reel

92-04234      core diameter: 76 mm  
 pieces per reel: 660 pieces  
 dispensed on the inside

1 reel

**Single labels zigzag folded with steam indicator, 88 x 35 mm**

REF		pack. unit
92-04219	imprint: with reference to the norm and the colour change tractor feed upper material with horizontal slit with tear-off perforation colour change: from pink to brown double self-adhesive	2400 pieces



**Single labels zigzag folded with steam indicator, 94 x 46 mm**

92-04013	tractor feed with tear-off perforation colour change: from pink to brown single self-adhesive	3000 pieces
----------	--	-------------



**Single labels zigzag folded with steam indicator, 99 x 37 mm**

	tractor feed with tear-off perforation colour change: from pink to brown double self-adhesive	
92-04002	imprint: blank	2500 pieces
92-04004	imprint: row disposition	2500 pieces

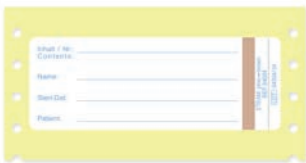



**Single labels on reel with steam and FO indicator, 60 x 31 mm**



92-04185	core diameter: 40 mm reel width: 64 mm pieces per reel: 1000 pieces dispensed on the inside colour change: from pink to brown / violet to green double self-adhesive	1 reel
----------	---	--------

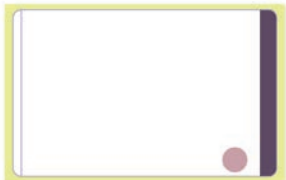

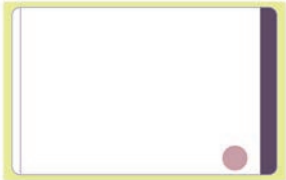

**Single labels on reel with steam and FO indicator, 63 x 40 mm**

REF		pack. unit	
92-04064	core diameter: 76 mm reel width: 67 mm pieces per reel: 2000 pieces dispensed on the outside colour change: from pink to brown / violet to green double self-adhesive	1 reel	 



**Single labels on reel with steam and FO indicator, 63 x 40 mm**

92-04058	core diameter: 40 mm reel width: 67 mm pieces per reel: 2000 pieces dispensed on the inside colour change: from pink to brown / violet to green double self-adhesive	1 reel	 
----------	---	--------	---

**Labels for Webeco on reel with steam and FO indicator, central perforation, 88.5 x 36 mm**

92-04065	upper material with slit core diameter: 40 mm with tear-off perforation reel width: 88.5 mm pieces per reel: 1000 pieces dispensed on the outside colour change: from pink to brown / violet to green double self-adhesive	1 reel	 
----------	---	--------	--

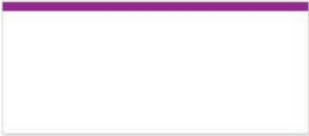
**Continuous labels on reel with steam indicator**

92-04098	core diameter: 76 mm reel width: 60 mm reel length: 100 m dispensed on the outside colour change: from pink to brown single self-adhesive	1 reel	 
----------	--	--------	--

**Continuous labels on reel with steam indicator and reference**

REF

pack. unit



92-04225  
92-04269

imprint: with reference to the colour change  
glue: extra powerful adhesive  
reel width: 70 mm  
reel length: 80 m  
dispensed on the outside  
colour change: from pink to brown  
double self-adhesive

core diameter: 50 mm  
core diameter: 76 mm

1 reel  
1 reel

**Continuous labels on reel with steam indicator, with special glue which minimizes the soiling of the cutter**



92-04142  
92-04268

imprint: with reference to the colour change  
reel width: 70 mm  
reel length: 80 m  
dispensed on the outside  
colour change: from pink to brown  
double self-adhesive

core diameter: 50 mm  
core diameter: 76 mm

1 reel  
1 reel

**Continuous labels on reel with steam indicator, suitable for non-woven materials**



92-04085  
92-04145

imprint: with reference to the colour change  
reel width: 70 mm  
reel length: 80 m  
dispensed on the outside  
colour change: from pink to brown  
double self-adhesive

core diameter: 50 mm  
core diameter: 76 mm

1 reel  
1 reel

**Continuous labels on reel, blank**



92-04093

core diameter: 50 mm  
reel width: 70 mm  
reel length: 80 m  
dispensed on the outside  
double self-adhesive

1 reel

**Continuous labels on reel with both-sided cleared border, with steam indicator**

 REF pack. unit

92-04181      imprint: with reference to the colour change  
 core diameter: 50 mm  
 reel width: 70 mm  
 reel length: 80 m  
 dispensed on the outside  
 colour change: from pink to brown  
 suitable for: non-woven materials  
 double self-adhesive

1 reel

**Continuous labels on reel with steam and FO indicator**

imprint: with reference to the colour change  
 reel width: 70 mm  
 reel length: 80 m  
 dispensed on the outside  
 colour change: from pink to brown / violet to green  
 double self-adhesive

92-04046      core diameter: 50 mm  
 92-04307      core diameter: 76 mm

1 reel  
 1 reel

**Continuous labels on reel with steam and EO indicator**

92-04045      imprint: with reference to the colour change  
 core diameter: 50 mm  
 reel width: 70 mm  
 reel length: 80 m  
 dispensed on the outside  
 colour change: from pink to brown / white to yellow  
 double self-adhesive

1 reel

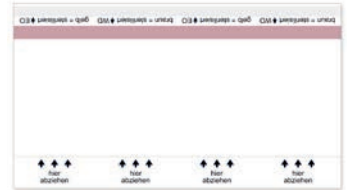
**Continuous labels on reel with steam indicator and colour bar**



imprint: with reference to the colour change  
 reel width: 70 mm  
 reel length: 80 m  
 dispensed on the outside  
 colour change: from pink to brown  
 double self-adhesive

92-04060      red  
 92-04061      green  
 92-04062      blue  
 92-04063      yellow  
 core diameter: 76 mm  
 92-04210      red  
 92-04211      green  
 92-04212      blue  
 92-04213      yellow

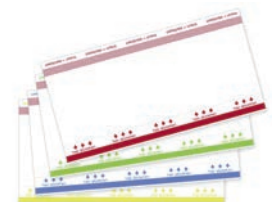

1 reel  
 1 reel  
 1 reel  
 1 reel  
 1 reel  
 1 reel  
 1 reel  
 1 reel



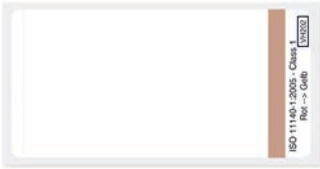

**Single labels on reel with H<sub>2</sub>O<sub>2</sub> indicator (plasma)**

REF			pack. unit
		core diameter: 40 mm with tear-off perforation reel width: 73 mm pieces per reel: 1000 pieces dispensed on the outside colour change: from yellow to blue	
92-04153		size: 70 x 35 mm, single self-adhesive	1 reel
92-04135		size: 70 x 33 mm, double self-adhesive	1 reel

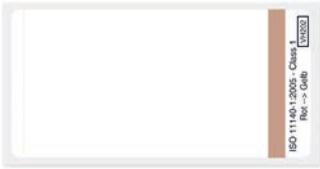

**Single labels on reel with H<sub>2</sub>O<sub>2</sub> indicator (plasma), tyvek, dispensed on the outside**

92-04278		imprint: with reference to the norm and the colour change size: 70 x 35 mm core diameter: 40 mm without tear-off perforation reel width: 75 mm pieces per reel: 1000 pieces colour change: from red to yellow double self-adhesive	1 reel
			

**Single labels on reel with H<sub>2</sub>O<sub>2</sub> indicator (plasma), tyvek, dispensed on the inside**

92-04279		imprint: with reference to the norm and the colour change size: 70 x 38 mm core diameter: 76 mm with tear-off perforation reel width: 75 mm pieces per reel: 1000 pieces colour change: from red to yellow double self-adhesive	1 reel
			

**Foil labels on reel for H<sub>2</sub>O<sub>2</sub> sterilization (plasma), PP-foil Top white/PET transparent**

92-04277		without indicator slit: left side size: 105 x 36 mm core diameter: 76 mm reel width: 107 mm pieces per reel: 1000 pieces dispensed on the outside double self-adhesive	1 reel
			



**Continuous labels on reel with H<sub>2</sub>O<sub>2</sub> indicator (plasma), double self-adhesive**

 REF pack. unit

	reel width: 70 mm	
	reel length: 30 m	
	dispensed on the outside	
	colour change: from yellow to blue	
92-04097	core diameter: 50 mm	1 reel
92-04297	core diameter: 76 mm	1 reel

**Continuous label on reel with H<sub>2</sub>O<sub>2</sub> indicator (plasma), single self-adhesive**

92-04091	core diameter: 50 mm	1 reel
	reel width: 70 mm	
	reel length: 30 m	
	dispensed on the outside	
	colour change: from yellow to blue	

**Thermo transfer foil, made of high wax/resin quality**

	black			
	autoclave-resistant			
	quality: wax/resin			
	size	core length	core ø	
	outside coated			
92-09882	45 mm x 300 m	45 mm	25.0 mm	1 reel
92-09855	57 mm x 74 m	57 mm	12.5 mm	1 reel
92-09270	70 mm x 300 m	70 mm	25.0 mm	1 reel
92-09854	80 mm x 300 m	80 mm	25.0 mm	1 reel
92-09452	85 mm x 74 m	110 mm	12.5 mm	1 reel
92-09856	85 mm x 74 m	110 mm	12.5 mm	1 reel
92-09062	90 mm x 300 m	90 mm	25.0 mm	1 reel
92-09853	110 mm x 74 m	110 mm	25.0 mm	1 reel
92-09262	110mm x 300m	110 mm	25,0 mm	1 reel
	inside coated			
92-09852	76 mm x 300 m	76 mm	25.0 mm	1 reel
92-09494	90 mm x 360 m	90 mm	25.0 mm	1 reel
92-09065	110mm x 300m	110 mm	25.0 mm	1 reel



**Thermo transfer foil, premium resin quality**

REF					pack. unit	
		black autoclave-resistant quality: resin smear-resistant: up to 150 °C				
		size	core length	core ø		
		outside coated				
		92-09486	80 mm x 300 m	80 mm	25.0 mm	1 reel
		92-09476	85 mm x 74 m	110 mm	12.5 mm	1 reel
		92-09858	85 mm x 74 m	110 mm	12.5 mm	1 reel
		inside coated				
		92-09232	110mm x 300m	110 mm	25.0 mm	1 reel

**Thermo transfer foil, made of high wax quality**

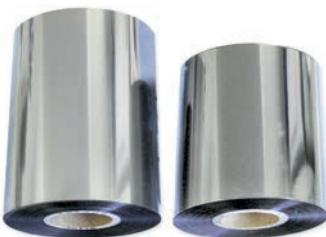
		black autoclave-resistant: limited suitable quality: wax				
		size	core length	core ø		
		outside coated				
		92-09078	60 mm x 300 m	60 mm	25.0 mm	1 reel
		92-09080	70 mm x 300 m	70 mm	25.0 mm	1 reel
		92-09077	80 mm x 300 m	80 mm	25.0 mm	1 reel
		92-09898	80 mm x 600 m	80 mm	25.0 mm	1 reel
		92-09213	85 mm x 74 m	110 mm	12.5 mm	1 reel
		92-09061	110mm x 300m	110 mm	25.0 mm	1 reel
		92-09212	110 mm x 74 m	110 mm	12.5 mm	1 reel
		inside coated				
		92-09067	60 mm x 300 m	60 mm	25.0 mm	1 reel
		92-09069	76 mm x 300 m	76 mm	25.0 mm	1 reel

**Labeler "PRINTEX", three lines**

		92-04230	text for three lines possible  per line 11 characters (only numbers)  matching labels see as follows	1 piece
		92-04232	Ink refill for labeler REF 04230	1 piece

**Labeler "METO", three lines**

<b>REF</b>		<b>pack. unit</b>
------------	--	-------------------

92-04019	text for three lines possible  per line 12 characters (only numbers) on request with text and special characters  matching labels see as follows	1 piece
----------	---	---------



92-04119	Ink refill for labeler REF 92-04019	2 pieces
----------	-------------------------------------	----------

**Single METO-labels on reel for labeler REF 92-04019 + 92-04230**

with steam indicator  
 size: 29 x 28 mm  
 pieces per reel: 400 pieces  
 double self-adhesive

92-04068	orange	12 reels
92-04069	white	12 reels
92-04070	red	12 reels
92-04071	green	12 reels
92-04072	blue	12 reels
92-04073	yellow	12 reels

**Single METO-labels on reel for labeler REF 92-04019 + 92-04230**

92-04206	green without indicator size: 29 x 28 mm pieces per reel: 700 pieces single self-adhesive	12 reels
----------	---	----------

**Labeler "MONARCH", three lines**

92-04014	text for three lines possible  top line with 12 characters (ABC123456789) middle line with 12 characters (012345678912) lower line with 12 characters (012345678912)  matching labels see as follows	1 piece
----------	--	---------



92-04018	Ink refill for labeler REF 92-04014	1 piece
----------	-------------------------------------	---------

**Single labels on reel for labeler REF 92-04014, without indicator**

REF		pack. unit
	size: 22.5 x 31 mm pieces per reel: 750 pieces double self-adhesive	
92-04040	green	12 reels
92-04041	blue	12 reels
92-04042	red	12 reels
92-04043	yellow	12 reels
92-04054	blank	12 reels



**Single labels on reel with steam indicator for labeler REF 92-04014, with steam indicator**

	size: 22.5 x 31 mm pieces per reel: 750 pieces double self-adhesive	
92-04048	orange	12 reels
92-04049	white	12 reels
92-04050	red	12 reels
92-04051	green	12 reels
92-04052	blue	12 reels
92-04053	yellow	12 reels

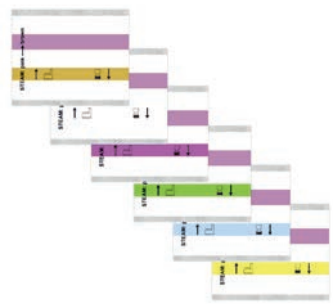

**Labeler "Printex", two lines**

92-04231	text for two lines possible  per line 10 characters (only numbers)  matching labels see as follows	1 piece
92-04233	Ink refill for labeler REF 04231	1 reel



**Single labels on reel for labeler REF 92-04231, not suitable for non-woven materials**

	white size: 26 x 16 mm pieces per reel: 500 pieces double self-adhesive	
92-04247	with steam indicator colour change: from pink to brown	12 reels
92-04248	without indicator	12 reels

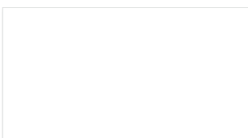
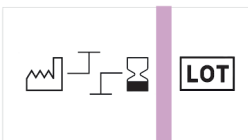

**Counting strips for processing cycles**

REF		pack. unit
	heat resistant: up to 134 °C washable	
92-09243	for 10 cycles (imprint No. 1 - 10) material: plastic	200 pieces
92-09245	for 10 additional cycles (imprint No. 11 - 20) material: plastic	200 pieces
92-09247	for 10 cycles material: silicone	100 pieces
92-09249	autoclave-resistant for 5 cycles (imprint No. 1 - 5) material: plastic	200 pieces

**Indicator strips with steam indicator**

	imprint: with documentation field and reference to the norm and the colour change colour change: from pink to brown size: 20 x 170 mm	
92-01161	with slit on the back single self-adhesive	1000 pieces
92-01410	without slit non-adhesive	1000 pieces

**Indicator strips with FO indicator**

	imprint: with documentation field and reference to the norm and the colour change colour change: from violet to green size: 20 x 170 mm	
92-01403	with slit on the back single self-adhesive	1000 pieces
92-01402	without slit non-adhesive	1000 pieces

**Indicator strips with EO indicator**

	imprint: with documentation field and reference to the norm and the colour change colour change: from white to yellow size: 20 x 170 mm	
92-01405	with slit on the back single self-adhesive	1000 pieces
92-01404	without slit non-adhesive	1000 pieces



**Indicator strips with EO indicator, also suitable for metal PCD's**

REF		pack. unit
92-08019	colour change: from white to yellow suitable for: metal test piece size: 6 x 75 mm single self-adhesive	200 pieces



**Set label with steam indicator**

92-04003	imprint: with documentation field and reference to the colour change size: 40 x 80 mm colour change: from pink to brown single self-adhesive	1000 pieces
----------	--	-------------

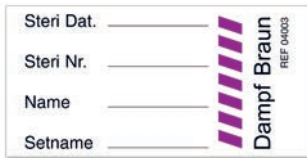

**Insertion cards for instrument trays with steam indicator**

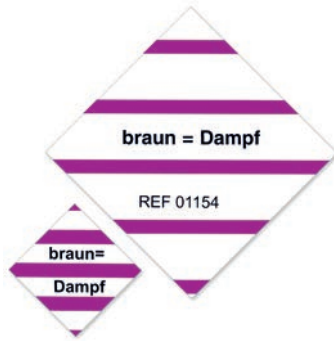

92-01150	imprint: on both sides colour change: from pink to brown size: 20 x 20 mm	1000 pieces
92-01154	size: 45 x 45 mm	1000 pieces

**Adhesive labels for laser printer, blank**

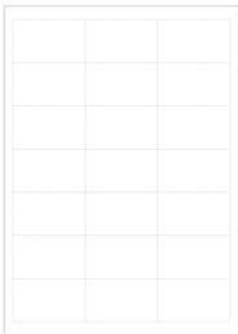

92-04285	label size: 65 x 39 mm 50 sheets with each 21 labels with tear-off perforation in the carrier material single self-adhesive	1050 pieces
----------	--	-------------

**Water soluble label on sheet**

REF		pack. unit	
92-04148	imprint: blank label size: 70 x 36 mm 100 sheets DIN A4 with each 24 labels glue: water soluble heat resistant: up to 134 °C self-adhesive	2400 pieces	

**Adhesive labels for laser printer with steam indicator**

	with steam indicator colour change: from pink to brown single self-adhesive		
92-04016	label size: 48.3 x 25.4 mm 25 sheets DIN A4 with each 44 labels	1100 pieces	
92-04017	label size: 63.5 x 38.1 mm 25 sheets DIN A4 with each 21 labels	525 pieces	

**Adhesive labels with EO indicator**

92-50043	label size: 100 x 50 mm 50 sheets with each 4 labels colour change: from white to yellow single self-adhesive	200 pieces	
----------	--	------------	---

**Indicator dots with EO indicator**

92-01406	label size: 10 x 10 mm 20 sheets with each 25 labels colour change: from white to yellow single self-adhesive	500 pieces	
----------	--	------------	---

**Indicator dots with EO indicator**

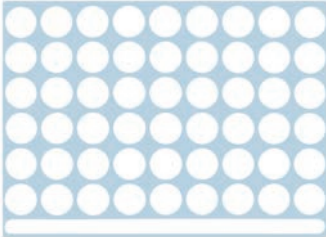
REF		pack. unit
92-01408	 <p>label size: Ø 16 mm 20 sheets with each 54 labels colour change: from white to yellow single self-adhesive</p>	1080 pieces

**Indicator dots on reel with EO indicator**

92-01414	 <p>label size: Ø 15 mm pieces per reel: 5000 pieces colour change: from white to yellow single self-adhesive</p>	1 reel
----------	---	--------

**Indicator strips with EO indicator**

92-01407	 <p>with slit on the back colour change: from white to yellow size: 15 x 50 mm single self-adhesive</p>	1000 pieces
----------	--	-------------

**Indicator dots with FO indicator**

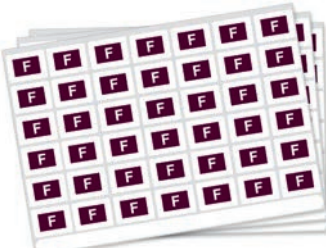
92-01415	 <p>colour change: from violet to green</p> <p>label size: 100 x 50 mm 20 sheets with each 42 labels, size: 16 x 22 mm single self-adhesive</p>	840 pieces
92-50050	<p>label size: 9 x 16 mm 10 sheets with each 320 labels self-adhesive</p>	3200 pieces



**Indicator dots on reel with steam indicator , ø 15 mm**

REF

pack. unit

92-01159 pieces per reel: 5000 pieces  
colour change: from pink to brown  
single self-adhesive

1 reel

**Indicator dots on reel with steam indicator, ø 10 mm**

92-01401 pieces per reel: 10000 pieces  
colour change: from pink to brown  
single self-adhesive

1 reel



**Indicator dots with gamma-indicator, dose range: >10 kGy (>1.0 Mrad)**

REF

pack. unit



label size: Ø 12.5 mm  
 colour change: from yellow to red  
 single self-adhesive

92-01417

pieces per reel: 1000 pieces

2 reels

92-01418

pieces per reel: 5000 pieces

1 reel

**Indicator strips with H<sub>2</sub>O<sub>2</sub> indicator (plasma)**

92-01411

with slit on the back  
 colour change: from yellow to blue  
 size: 20 x 170 mm  
 material: tyvek  
 self-adhesive

200 pieces



**KeyDot – 2D Data Matrix for Instrument Tracking (pieces per sheet: 100 pieces)**



92-ID40501  
 92-ID40502  
 92-ID40505  
 92-ID40510  
 92-ID40001  
 92-ID40002  
 92-ID40005  
 92-ID40010  
 92-ID41001  
 92-ID41002  
 92-ID41005  
 92-ID41010  
 92-ID42001  
 92-ID42002  
 92-ID42005  
 92-ID42010

2D Barcode Ø 3,17 mm  
 2D Barcode Ø 3,17 mm  
 2D Barcode Ø 3,17 mm  
 2D Barcode Ø 3,17 mm  
 2D Barcode Ø 3,17 mm  
 2D Barcode Ø 4,80 mm  
 2D Barcode Ø 4,76mm  
 2D Barcode Ø 4,76 mm  
 2D Barcode Ø 6,35 mm  
 2D Barcode Ø 6,35 mm  
 2D Barcode Ø 6,35 mm  
 2D Barcode Ø 6,35 mm  
 2D Barcode Ø 9,53 mm  
 2D Barcode Ø 9,53 mm  
 2D Barcode Ø 9,53 mm  
 2D Barcode Ø 9,53 mm

1 sheet  
 2 sheets  
 5 sheets  
 10 sheets  
 1 sheet  
 2 sheets  
 5 sheets  
 10 sheets  
 1 sheet  
 2 sheets  
 5 sheets  
 10 sheets  
 1 sheet  
 2 sheets  
 5 sheets  
 10 sheets

**Indicator dots with H<sub>2</sub>O<sub>2</sub> indicator (plasma)**

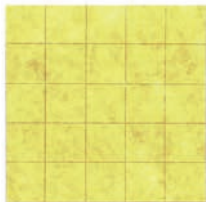

92-01413

label size: 10 x 10 mm  
 25 pieces  
 colour change: from yellow to blue  
 material: tyvek  
 single self-adhesive

500 pieces

**Identification label with H<sub>2</sub>O<sub>2</sub> indicator (plasma), tyvek**

92-04103

size: 60 x 40 mm  
 colour change: from yellow to blue  
 single self-adhesive

1000 pieces



**Sterilization control card with steam indicator**

REF		pack. unit
92-01162	with imprint: Sterilisationskontrolle / Sterilization Control, Datum / Date, Ladungs-Nr. / Load-No.:, Steri-No.:, Lot-No.:, Unterschrift / Signature, Etikett / Label, Menge / Quantity, Inhalt / Contents, Indikator akzeptiert / nicht akzeptiert with steam indicator size: 148 x 105 mm colour change: from light yellow to black	1000 pieces

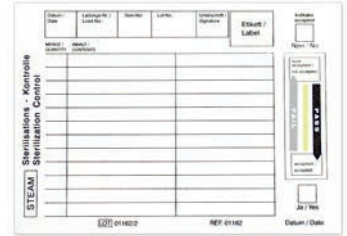
**Repair tags made of synthetic material**

92-01260	orange with imprint: "reparieren / repair"	100 pieces
92-02629	red with imprint: "reparieren / repair"	100 pieces
92-01261	yellow with imprint: "à réparer / da ripare"	100 pieces
92-01278	red with imprint: "schärfen / sharpen"	100 pieces

**Repair tags made of Tyvek**



	sterilizable: not with steam washable: up to 90 °C material: tyvek	
92-01007	with imprint: "defekt / damaged" size: 160 x 30 mm	1000 pieces
92-04121	blank size: 160 x 30 mm	1000 pieces
92-04132	blank size: 190 x 30 mm	1000 pieces

**Repair tag made of PET, blank**

92-04151	size: 190 x 30 mm heat resistant: up to 134 °C washable: up to 90 °C	500 pieces
----------	--	------------



**Tie-on labels made of carton with hole, non-adhesive**

REF			pack. unit
		to affix to containers with plastic seals heat resistant: up to 134 °C	
			
			
92-04162	white	size: 90 x 50 + 20 mm	1000 pieces
92-04192	red		1000 pieces
92-04193	blue		1000 pieces
92-04194	yellow		1000 pieces
92-04195	green		1000 pieces
92-04216	white	size: 110 x 60 + 20 mm	1000 pieces
92-04289	red, coloured 1-sided		1000 pieces
92-04237	white	size: 160 x 100 + 20 mm	1000 pieces

**Tie-on labels made of paper, non-adhesive**

		92-04172	to affix to containers with plastic seals, with cross slot	1000 pieces
			white	
			size: 75 x 40 + 20 mm	
			heat resistant: up to 134 °C	

**Dispenser for labels**

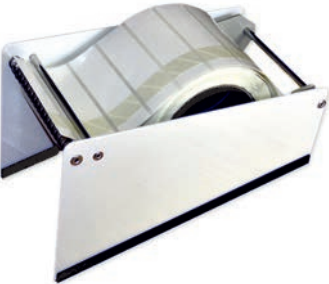
		92-09000	for example: for REF 92-01001 or 92-01002	1 piece
			number of reels: 1 reel	
			maximum label width: 120 mm	

**Dispenser for labels**

		92-06013	suitable for inside and outside dispensed reels	1 piece
			number of reels: till 4 reels	
			maximum label width: 250 mm	

**Adhesive tapes with indicator**

REF		pack. unit
	beige with steam indicator colour change: from green to dark	
92-01130	18 mm x 50 m	1 reel
92-01505	24 mm x 50 m	1 reel
	glue: strong adhesive suitable for: non woven	
	blue with steam indicator colour change: from green to dark	
92-01500	19 mm x 50 m	1 reel
92-01506	25 mm x 50 m	1 reel
	white with hot-air indicator colour change: from green to brown	
92-01151	19 mm x 50 m	1 reel



## Adhesive crepe tapes without indicator

REF		pack. unit
92-01132	white, 19 mm x 50 m, normal-adhesive	1 reel
92-01507	white, 25 mm x 50 m, normal-adhesive	1 reel
92-01501	suitable for: non woven blue, 19 mm x 50 m, strong adhesive	1 reel
92-01508	blue, 25 mm x 50 m, strong adhesive	1 reel
92-01511	blue, 19 mm x 50 m, extra strong adhesive	1 reel



## Adhesive crepe tape without indicator

92-01502	brown 50 mm x 50 m	1 reel
----------	-----------------------	--------

Adhesive foil tape without indicator for H<sub>2</sub>O<sub>2</sub> sterilization

92-01515	19 mm x 66 m	1 reel
----------	--------------	--------



## Foil labels

	for marking containers	
	without indicator	
	glue: removable without trace	
	pieces per reel: 500 pieces	
	dispensed on the outside	
	heat resistant: up to 134 °C	
	core diameter: 76 mm	
	single self-adhesive	
92-01002	size: 102 x 25 mm	1 reel
92-04096	size: 70 x 33 mm	1 reel

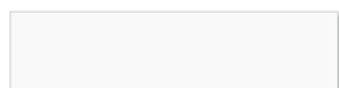

**Dispenser for 1 reel adhesive tape**

REF		pack. unit
92-09001	version: heavy duty design maximum reel width: 25 mm	1 piece
92-09005	Replacement knife for dispenser (REF 92-09001)	1 piece

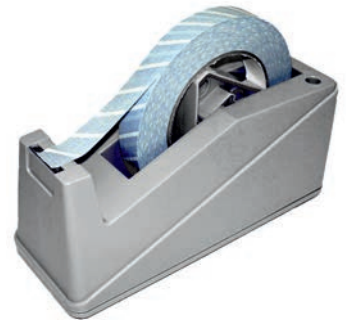
**Dispenser for 1 reel adhesive tape**

92-09035	strip length can be preset from 1 cm to 10 cm  version: with tape dispenser maximum reel width: 25 mm	1 piece
92-09036	Knife holder for dispenser (REF 92-09035)	1 piece
92-09007	Replacement knife for dispenser (REF 92-09035)	1 piece

**Dispenser for up to 2 reels adhesive tape**

92-09002	version: heavy duty desing for one 50 mm wide adhesive tape reel or two reels with 25 mm each	1 piece
----------	---	---------

**Dispenser for up to 2 reels adhesive tape**

92-09003	can be rotated 360°  version: with bolts and suction cup assembling for one 50 mm wide adhesive tape reel or two reels with 25 mm each	1 piece
----------	--	---------



**Dispenser for 4 reels adhesive tape**

REF

pack. unit

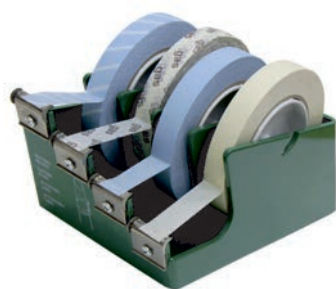

92-09063

version: heavy duty design  
maximum reel width: 25 mm

1 piece

**Dispenser for labels, for 1 reel**

92-09000

for example: for REF 92-01001 or 92-01002

1 piece

number of reels: 1 reel  
maximum label width: 120 mm

**Dispenser for labels, for up to 4 reels**

92-06013

suitable for inside and outside dispensed reels

1 piece

maximum label width: 250 mm



**Identification tapes on reel, 6 mm x 66 m**

pack. unit

 core diameter: 76 mm  
 heat resistant: up to 134 °C

92-01796	red/white with symbol "for single use only"	1 reel
92-01797	red, without imprint	1 reel

**Identification adhesive tape**

 width: 6,4 mm  
 Running lenght: 6,4 m  
 RDG-suitable  
 Heat resistant up to 134°C

 width: 3,4 mm  
 Running lenght: 6,4 m  
 RDG-suitable  
 Heat resistant up to 134°C

















 width: 9,4 mm  
 Running lenght: 6,4 m  
 RDG-suitable  
 Heat resistant up to 134°C

92-T-02-02	blue	T-01-01	white	T-03-01	white
92-T-02-03	green	T-01-02	blue	T-03-02	blue
92-T-02-04	red	T-01-03	green	T-03-03	green
92-T-02-05	yellow	T-01-04	red	T-03-04	red
92-T-02-07	orange	T-01-05	yellow	T-03-05	yellow
92-T-02-09	black	T-01-06	violet	T-03-06	violet
		T-01-07	orange	T-03-07	orange
		T-01-08	brown	T-03-08	brown
		T-01-09	black	T-03-09	black

**Identification strips**

 each bow contains:  
 11 adhesive strips, each 51 mm long  
 11 adhesive strips, each 127 mm long  
 44 adhesive strips, each 38 mm long  
 231 adhesive strips, each 25 mm long

 heat resistant: up to 134 °C  
 adhesive tape width: 6.35 mm

92-T-120-01	white	1 sheet	
92-T-120-02	blue	1 sheet	
92-T-120-03	green	1 sheet	
92-T-120-04	red	1 sheet	
92-T-120-05	yellow	1 sheet	
92-T-120-06	violet	1 sheet	
92-T-120-07	orange	1 sheet	
92-T-120-08	brown	1 sheet	
92-T-120-09	black	1 sheet	
92-T-120-12	grey	1 sheet	
92-T-120-15	lavender	1 sheet	
92-T-120-16	beige	1 sheet	
92-T-120-14	light blue	1 sheet	
92-T-120-13	light green	1 sheet	
92-T-120-11	rose	1 sheet	
92-T-120-17	plum	1 sheet	
92-T-120-21	mint green	1 sheet	

**Identification strips with diagonal stripes**

REF

pack. unit



Each sheet contains:

- 11 adhesive strips, each 51 mm long
- 11 adhesive strips, each 127 mm long
- 44 adhesive strips, each 38 mm long
- 231 adhesive strips, each 25 mm long

all strips are 6.35 mm wide  
heat-resistant: up to 134 ° C

92-T-320-0906	violet	1 sheet
92-T-320-0907	orange	1 sheet
92-T-320-0902	blue	1 sheet
92-T-320-0904	rubine	1 sheet
92-T-320-0905	yellow	1 sheet
92-T-320-0903	green	1 sheet
92-T-320-0909	white	1 sheet

**Identification strips, each sheet contains number 0 - 8**



each sheet contains

- 44 strips / 50 mm length
- 44 strips / 38 mm length
- 220 strips / 25 mm length

heat resistant: up to 134 ° C  
adhesive tape width: 6.35 mm

92-01723	red	1 sheet
92-01724	blue	1 sheet
92-01725	green	1 sheet
92-01726	violet	1 sheet

**Identification strips with dots**

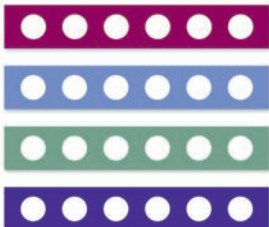

each sheet contains

- 44 strips / 50 mm length
- 44 strips / 38 mm length
- 220 strips / 25 mm length

heat resistant: up to 134 ° C  
adhesive tape width: 6.35 mm

92-01727	red	1 sheet
92-01728	blue	1 sheet
92-01729	green	1 sheet
92-01730	violet	1 sheet

**Identification strips with stars**

REF		pack. unit
	each sheet contains 44 strips / 50 mm length 44 strips / 38 mm length 220 strips / 25 mm length  heat resistant: up to 134 °C adhesive tape width: 6.35 mm	
92-01731	red	1 sheet
92-01732	blue	1 sheet
92-01733	green	1 sheet
92-01734	violet	1 sheet

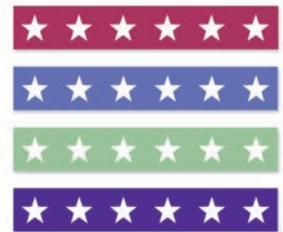
**Identification strips with triangles**

	each sheet contains 44 strips / 50 mm length 44 strips / 38 mm length 220 strips / 25 mm length  heat resistant: up to 134 °C adhesive tape width: 6.35 mm	
92-01735	red	1 sheet
92-01736	blue	1 sheet
92-01737	green	1 sheet
92-01738	violet	1 sheet

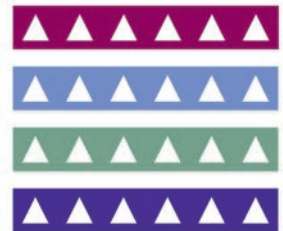
**Identification strips, four-colour**

	each sheet contains 44 strips / 50 mm length 44 strips / 38 mm length 220 strips / 25 mm length  heat resistant: up to 134 °C adhesive tape width: 6.35 mm	
92-01740	red - yellow - purple - orange	1 sheet
92-01741	blue - white - black - green	1 sheet

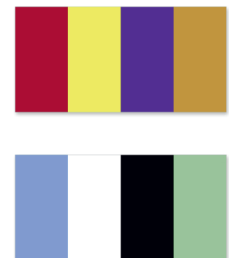
**Identification strips, striped**

	Each sheet contains: 11 adhesive strips, each 51 mm long 11 adhesive strips, each 127 mm long 44 adhesive strips, each 38 mm long 231 adhesive strips, each 25 mm long all strips are 6.35 mm wide  heat-resistant: up to 134 °C	
92-T-310-0901	black - white	1 sheet
92-T-310-0903	black - green	1 sheet
92-T-310-0904	black - red	1 sheet
92-T-310-0905	black - yellow	1 sheet
92-T-310-0910	black - orange	1 sheet
92-T-310-0912	black - grey	1 sheet

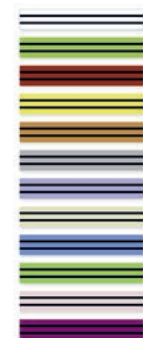

**Identification strips, striped**

	REF		pack. unit
	92-01748	black - lavender	1 sheet
	92-01749	black - beige	1 sheet
	92-01750	black - light blue	1 sheet
	92-01751	black - neon-green	1 sheet
	92-01752	black - rose	1 sheet
	92-01753	black - plum	1 sheet

**Identification strips, striped**



	each sheet contains		
	44 strips / 50 mm length		
	44 strips / 38 mm length		
	220 strips / 25 mm length		
	heat resistant: up to 134 °C		
	adhesive tape width: 6.35 mm		
92-01754	white - blue	1 sheet	
92-01755	white - green	1 sheet	
92-01756	white - red	1 sheet	
92-01757	white - yellow	1 sheet	
92-01758	white - orange	1 sheet	
92-01759	white - brown	1 sheet	
92-01760	white - black	1 sheet	
92-01761	white - lavender	1 sheet	
92-01762	white - light blue	1 sheet	
92-01763	white - neon-green	1 sheet	
92-01764	white - rose	1 sheet	
92-01765	white - plum	1 sheet	

**Identification strips, striped**



	each sheet contains		
	44 strips / 50 mm length		
	44 strips / 38 mm length		
	220 strips / 25 mm length		
	heat resistant: up to 134 °C		
	adhesive tape width: 6.35 mm		
92-01766	red - white - blue	1 sheet	
92-01767	red - white - black	1 sheet	
92-01768	red - yellow - black	1 sheet	
92-01769	red - black - green	1 sheet	

**Identification strips, striped**

REF		pack. unit
	each sheet contains 44 strips / 50 mm length 44 strips / 38 mm length 220 strips / 25 mm length	
	heat resistant: up to 134 °C adhesive tape width: 6.35 mm	
92-01770	blue - green	1 sheet
92-01771	blue - red	1 sheet
92-01772	yellow - blue	1 sheet
92-01773	yellow - green	1 sheet
92-01774	yellow - red	1 sheet

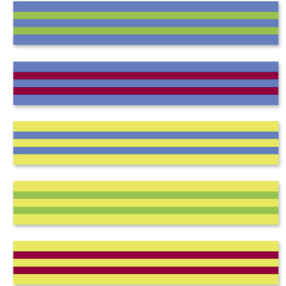
**Identification strips, assorted symbols**



	each sheet contains 44 strips / 50 mm length 44 strips / 38 mm length 220 strips / 25 mm length	
	heat resistant: up to 134 °C adhesive tape width: 6.35 mm	
92-01775	white, design: red hearts	1 sheet
92-01776	red, design: white hearts	1 sheet
92-01777	yellow, design: black smileys	1 sheet
92-01778	pink, design: white alphabet (A - E)	1 sheet

**Identification strips, with special symbols**

	each sheet contains 44 strips / 50 mm length 44 strips / 38 mm length 220 strips / 25 mm length	
	heat resistant: up to 134 °C adhesive tape width: 6.35 mm	
92-01785	coding: blue - GEN	1 sheet
92-01786	coding: light blue - OB/GYN	1 sheet
92-01787	coding: red - CARDIAC	1 sheet
92-01788	coding: orange - NEURO	1 sheet
92-01790	coding: green - ORTHO	1 sheet
92-01791	coding: purple - ER ER	1 sheet



## Identification dots

	REF		pack. unit
 		glue: strong adhesive core diameter: 40 mm pieces per reel: 500 pieces heat resistant: up to 134 °C adhesion dot ø: 10 mm	
	92-01779	red	1 reel
	92-01780	yellow	1 reel
	92-01781	blue	1 reel
	92-01782	green	1 reel
	92-01783	black	1 reel
	92-01784	white	1 reel

## Laminated tapes for labelling machine P-touch, 24 mm x 8 m

		heat resistant: up to 134 °C font colour: black washable	
	92-09501	tape colour: clear	1 piece
	92-09502	tape colour: white	1 piece
	92-09503	tape colour: red	1 piece
	92-09504	tape colour: blue	1 piece
	92-09505	tape colour: yellow	1 piece
	92-09506	tape colour: green	1 piece
	92-09554	tape colour: silver-matt	1 piece

## Laminated tapes for labelling machine P-touch, 24 mm x 5 m

		heat resistant: up to 134 °C font colour: black washable	
	92-09507	tape colour: fluorescent-orange	1 piece
	92-09508	tape colour: fluorescent-yellow	1 piece

## Laminated tapes for labelling machine P-touch, 18 mm x 8 m

		heat resistant: up to 134 °C font colour: black washable	
	92-09510	tape colour: clear	1 piece
	92-09511	tape colour: white	1 piece
	92-09512	tape colour: red	1 piece
	92-09513	tape colour: blue	1 piece
	92-09514	tape colour: yellow	1 piece
	92-09515	tape colour: green	1 piece

**Laminated tapes for labelling machine P-touch, 18 mm x 8 m**

REF

pack. unit

heat resistant: up to 134 °C  
font colour: white  
washable

92-09541 tape colour: clear  
92-09516 tape colour: black

1 piece  
1 piece

**Laminated tapes for labelling machine P-touch, 12 mm x 8 m**

heat resistant: up to 134 °C  
font colour: black  
washable

92-09517 tape colour: clear  
92-09518 tape colour: white  
92-09519 tape colour: red  
92-09520 tape colour: blue  
92-09521 tape colour: yellow  
92-09522 tape colour: green  
92-09556 tape colour: silver-matt

1 piece  
1 piece  
1 piece  
1 piece  
1 piece  
1 piece  
1 piece

**Laminated tapes for labelling machine P-touch, 12 mm x 8 m**

heat resistant: up to 134 °C  
font colour: white  
washable

92-09549 tape colour: clear  
92-09523 tape colour: black  
92-09542 tape colour: blue

1 piece  
1 piece  
1 piece

**Laminated tapes for labelling machine P-touch, 12 mm x 5 m**

heat resistant: up to 134 °C  
font colour: black  
washable

92-09525 tape colour: fluorescent-orange  
92-09526 tape colour: fluorescent-yellow

1 piece  
1 piece



Laminated tapes for labelling machine P-touch, 9 mm x 8 m

REF			pack. unit
	 <p><b>LAMINATED</b> 9 mm 8m</p>	heat resistant: up to 134 °C font colour: black washable	
92-09528		tape colour: clear	1 piece
92-09529		tape colour: white	1 piece
92-09530		tape colour: red	1 piece
92-09531		tape colour: blue	1 piece
92-09532		tape colour: yellow	1 piece
92-09533		tape colour: green	1 piece

Laminated tapes for labelling machine P-touch, flexible tape , 9 mm x 8 m

	 <p><b>FLEXIBLE ID</b> 9 mm 8m</p>	heat resistant: up to 134 °C tape colour: white font colour: black washable	1 piece
92-09546			

Laminated tapes for labelling machine P-touch, flexible tape , 12 mm x 8 m

	 <p><b>FLEXIBLE ID</b> 12 mm 8m</p>	heat resistant: up to 134 °C tape colour: white font colour: black washable	1 piece
92-09535			

Laminated tapes for labelling machine P-touch, flexible tape , 18 mm x 8 m

	 <p><b>FLEXIBLE ID</b> 18 mm 8m</p>	heat resistant: up to 134 °C tape colour: white font colour: black washable	1 piece
92-09547			



**Laminated tapes for labelling machine P-touch, flexible tape , 24 mm x 8 m**

 REF pack. unit

 heat resistant: up to 134 °C  
 font colour: black  
 washable

 92-09548 tape colour: white  
 92-09550 tape colour: yellow

 1 piece  
 1 piece

**Tapes for labelling machine P-touch, non laminated, 12 mm x 8 m**

 92-09553 heat resistant: up to 134 °C  
 tape colour: white  
 font colour: black  
 washable

1 piece

**Tapes for labelling machine P-touch, non laminated, 18 mm x 8 m**

 92-09544 heat resistant: up to 134 °C  
 tape colour: white  
 font colour: black  
 washable

1 piece

**Tapes for labelling machine P-touch, non laminated, 24 mm x 8 m**

 92-09543 heat resistant: up to 134 °C  
 tape colour: white  
 font colour: black  
 washable

1 piece



## Laminated tapes for labelling machine P-touch, with low adhesive strength, 12 mm x 8 m

REF

pack. unit



92-09551

heat resistant: up to 134 °C  
tape colour: white  
font colour: black  
washable

1 piece

## Lettering machine brother P-touch - PT-H105



92-09558

- accepts TZ Tapes 3.5 mm, 6 mm, 9 mm, 12 mm
- 8 character styles
- horizontal and vertical print
- max. print height: 9 mm
- battery is not included

1 piece

## Lettering machine P-touch - PT-2730VP - the professional lettering solution



3 YEAR WARRANTY

92-09500

- navigation dial
- graphic LCD with backlight, 3 lines x 16 characters
- up to 24 mm tape width
- 2800 characters memory, stores last message
- 8 fonts, 10 print styles, 8 print sizes, 15 frame styles
- vertical printing, repeated printing, multiline printing, mirror printing, tab function
- 55 pre-programmed label examples, adjustable label length, 9 built-in barcodes, multi-block (up to 5 blocks)
- automatic tape cutter

1 piece

option: adaptor

## Stencil tape for chemical etching



92-09536

tape colour: white  
font colour: black

size: 24 mm x 3 m



1 piece

92-09537



size: 18 mm x 3 m

1 piece

**Washable keyboard**

REF		pack. unit	
	for manual wet cleaning		
	port: corded keyboard layout: QWERTZ		
92-09614	white with 180 cm extension cable and a protective cap	1 piece	
92-09619	black made of silicone	1 piece	

**Washable mouse**

	for manual wet cleaning, with 2 buttons and sensor scroll wheel		
	port: corded		
92-09617	white	1 piece	
92-09618	black	1 piece	

**Washable mouse - white**

92-09616	for manual wet cleaning, with 2 buttons, 3 buttons scroll wheel emulation, with silicone shell	1 piece	
	port: corded		

**Mousepad with teflon coating**

92-06010	Due to the Teflon-coating the PC-mouse slides very smoothly across the surface. The bottom-side provides a very strong grip.	1 piece	
	brown heat resistant: up to 134 °C size: 170 x 230 mm suitable for: all kinds of mice material thickness: 0.31 mm topside: teflon underside: silicone (anti slip) washable in washer-disinfector		

**Fixing rings for colour marking**

REF		pack. unit
	to affix mesh basket labels, for colour marking, identification, etc.	
	heat resistant: up to 134 °C size: 10 mm inner diameter	
		
92-09418	blue	100 pieces
92-09419	green	100 pieces
92-09420	white	100 pieces
92-09421	red	100 pieces
92-09422	yellow	100 pieces
92-09423	orange	100 pieces
92-09424	violet	100 pieces
92-09425	black	100 pieces
92-09426	transparent	100 pieces

**Marking strips for marking sterilization containers**

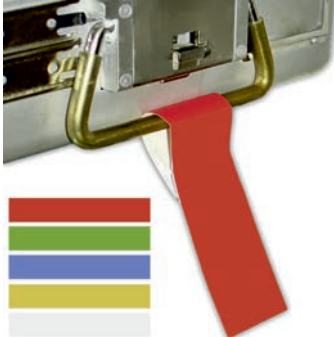
	with slit on the back size: 40 x 175 mm self-adhesive	
92-01739	red	1000 pieces
92-01792	green	1000 pieces
92-01793	blue	1000 pieces
92-01794	yellow	1000 pieces
92-01795	white	1000 pieces

**Water soluble label on sheet**

	92-04148	imprint: blank label size: 70 x 36 mm 100 sheets DIN A4 with each 24 labels glue: water soluble heat resistant: up to 134 °C self-adhesive	2400 pieces
---	----------	---	-------------

**edding 400 permanent marker, with round tip**

	line thickness: 1.0 mm ink: lightproof, fast drying	
		
92-09086	black	10 pieces
92-09087	blue	10 pieces
92-09170	red	10 pieces

**edding 8400 permanent marker**

REF		pack. unit
92-05504	black line thickness: 0.5 - 1.0 mm ink: lightproof, fast drying	10 pieces

**edding 950 industry painter - highly permanent colour paste with excellent opacity**

92-09088	lightfast, smudgeproof and water-resistant after drying, particularly suitable for marking rough surfaces and metals  black line thickness: 10.0 mm ink: lightproof	10 pieces
----------	---	-----------

**edding 8010 x-ray marker - radiograph marker with metal-framed round tip**

92-09089	for marking x-ray films  white mark: permanent line thickness: 0.8 mm ink: low odour, opaque lacquer ink	10 pieces
----------	---	-----------

**edding 8020 skin marker with round tip**

	for use in radiology, radiotherapy and nuclear medicine, and also by surgeons and dermatologists  mark: permanent line thickness: 1.0 mm ink: low odour	
92-09090	red	10 pieces
92-09091	blue	10 pieces



## edding 8040 laundry marker with round tip

REF		pack. unit
92-09092	for waterproof and boil-proof marking of nearly all kinds of textiles	10 pieces
	black mark: permanent line thickness: 1.0 mm ink: low odour	



## Permanent marker, sterilization proof

	mark: permanent line thickness: 0.75 mm	
92-05505	black	10 pieces
92-05513	red	10 pieces



## SteriLiner, sterilization proof

92-05514	black mark: permanent line thickness: 1.0 mm	10 pieces
----------	--	-----------



## Silicone ident pearls mini, for identification of instruments

	for ring instruments up to max. 4.0 mm diameter	
	heat resistant: up to 134 °C for single use	
92-09271	turquoise	100 pieces
92-09272	green	100 pieces
92-09273	blue	100 pieces
92-09274	yellow	100 pieces
92-09275	black	100 pieces
92-09276	red	100 pieces
92-09277	white	100 pieces
92-09278	orange	100 pieces
92-09279	brown	100 pieces
92-09280	grey	100 pieces
92-09281	violet	100 pieces

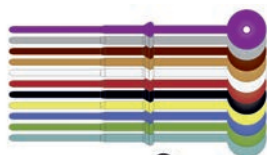

**Silicone ident pearls maxi, for identification of instruments**

REF		pack. unit
	for ring instruments up to max. 8.0 mm diameter	
	heat resistant: up to 134 °C for single use	
92-09289	turquoise	100 pieces
92-09290	green	100 pieces
92-09291	blue	100 pieces
92-09292	yellow	100 pieces
92-09293	black	100 pieces
92-09294	red	100 pieces
92-09295	white	100 pieces
92-09296	orange	100 pieces
92-09297	brown	100 pieces
92-09298	grey	100 pieces
92-09299	violet	100 pieces

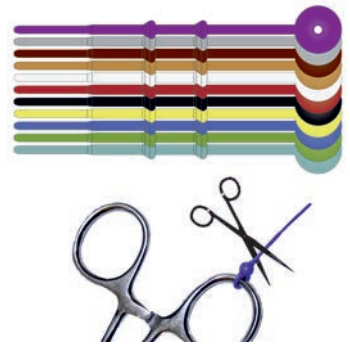
**Silicone ident pearls super maxi, for identification of instruments**

	for instruments from 10 mm up to 20 mm diameter	
	heat resistant: up to 134 °C for single use	
92-09652	turquoise	100 pieces
92-09653	green	100 pieces
92-09654	blue	100 pieces
92-09655	yellow	100 pieces
92-09656	black	100 pieces
92-09657	red	100 pieces
92-09658	white	100 pieces
92-09659	orange	100 pieces
92-09660	brown	100 pieces
92-09661	grey	100 pieces
92-09662	violet	100 pieces

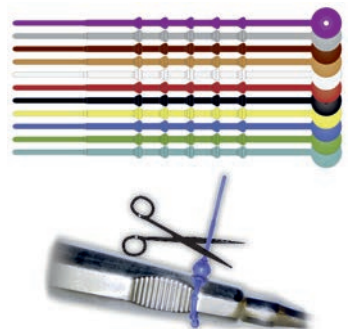
**Ident loops mini, made of polypropylene (PP), for identification of instruments**

	for ring instruments up to max. 3.5 mm diameter	
	sterilizable for single use	
92-09620	light blue	500 pieces
92-09621	dark blue	500 pieces
92-09622	light green	500 pieces
92-09623	dark green	500 pieces
92-09625	rose	500 pieces
92-09627	light yellow	500 pieces
92-09628	orange	500 pieces
92-09629	brown	500 pieces
92-09630	black	500 pieces
92-09631	light violet	500 pieces



**Ident loops maxi, made of polypropylene (PP), for identification of instruments**

REF

pack. unit

for ring instruments up to max. 6.0 mm diameter

sterilizable  
for single use



92-09639	light blue	500 pieces
92-09640	dark blue	500 pieces
92-09641	light green	500 pieces
92-09642	dark green	500 pieces
92-09643	white	500 pieces
92-09644	rose	500 pieces
92-09645	dark red	500 pieces
92-09646	light yellow	500 pieces
92-09647	orange	500 pieces
92-09648	brown	500 pieces
92-09649	black	500 pieces
92-09650	light violet	500 pieces
92-09651	turquoise	500 pieces
92-09695	grey	500 pieces

**Ident loops super maxi, made of polypropylene (PP), for identification of instruments**

for instruments up to max. 7.0 mm diameter

sterilizable  
for single use



92-09664	dark blue	100 pieces
92-09665	light green	100 pieces
92-09666	dark green	100 pieces
92-09667	white	100 pieces
92-09668	rose	100 pieces
92-09669	dark red	100 pieces
92-09670	light yellow	100 pieces
92-09671	orange	100 pieces
92-09672	brown	100 pieces
92-09673	black	100 pieces
92-09675	turquoise	100 pieces

**Label holder made of stainless steel for UTZ-boxes**

92-20433

50 pieces





**Plastic boxes e.g. for ident pearls or ident loops**

REF

pack. unit

transparent

5 - 11 compartments possible

92-09819

size: 270 x 185 mm 42 mm  
with 17 compartments

1 piece

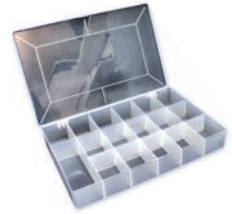

REF

**Refill packs for test equipment according to DIN 58298**

pack. unit

92-08502

for surgical scissors

1 pack

**Refill packs for test equipment according to DIN 58298**

92-08503

1 pack



- for forceps
- for chisels, raspatories, bone curettes and gouges

**SEAL PROOF**

REF		pack. unit
	<p>To test rotary sealers. Deviations (sealing temperature, sealing pressure) are visible on the indicator.</p> <ul style="list-style-type: none"> <li>1. Put the test sheet into your flat pouch.</li> <li>2. Pass it through the sealer once.</li> </ul>	
92-08011	size: 173 x 91 mm for pouches made of paper / film	250 pieces
92-08022	size: 173 x 91 mm for pouches made of paper / film	50 pieces
92-08017	size: 172 x 90 mm for pouches made of tyvek	100 pieces



	REF		pack. unit
<b>STERIKING Seal Control</b>			
	92-08021	<p>Sterilization packages have to be sealed to prevent the ingress of microorganisms and the sealing process needs to be validated accordingly. Under the new ISO standard 11607-2: 2006 users and processors are responsible to carry out a process validation program demonstrating the efficacy and reproducibility of all sterilization and packaging processes. The Steriking® Seal Control sheet SC250 enables users to validate sealers and seal quality reliably and rapidly.</p> <p>Simulation for pouches made of paper / film</p> <p>size: 205 x 150 mm</p>	250 pieces

**InkCheck**

REF		pack. unit
92-08101	<p>Standard routine monitoring test method for detecting seal leaks, seal integrity test according to DIN EN ISO 11607-1, annex B / ASTM F1929 for the routine monitoring of your sealing device.</p> <ul style="list-style-type: none"> <li>• according to DIN EN ISO 11607-1, annex B (ASTM F1929)</li> <li>• ready for use ampule with 2 ml dye penetrant solution</li> <li>• no complicated extraction/metering of the indicator liquid</li> <li>• easy to open by Twist-off seal</li> <li>• no spills / no splashes</li> <li>• suitable for most of the common paper-/Tyvek®-packaging</li> <li>• fast result / easy to interpret (5 seconds per seal)</li> </ul> <p>Set consisting of:</p> <ul style="list-style-type: none"> <li>• 50 tests of 2 ml</li> <li>• magnifying card (REF 08529)</li> </ul>	1 set

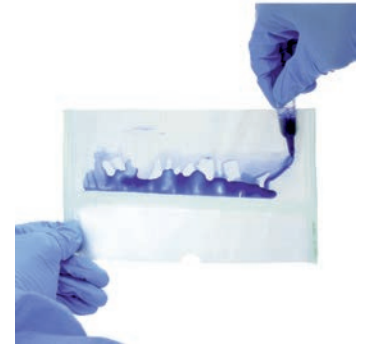
**LED-Magnifying lamp (80cm)**

	<ul style="list-style-type: none"> <li>• table lamp with adjustable arm</li> <li>• on/off switch on lamp</li> <li>• hinged cover to protect the lens</li> <li>• easy to clean</li> <li>• internal springs</li> <li>• light colour: Daylight (6500K)</li> </ul>	1 piece
92-09973	<p>white</p> <p>material: metal and plastic, 9 W</p> <p>attachment: table clip with screw fitting</p> <p>clamping area: 6,5 cm</p> <p>lens diameter: 150</p> <p>dioptrics: 5</p> <p>2.5 x zoom</p> <p>operating voltage: 230 V</p>	



	REF		pack. unit
<b>Magnifying lamps with 12 W fluorescent ring</b>			



- on/off switch integrated into base
- hinged cover to protect the lens
- easy to clean
- light colour: cold white

92-09978	white material: rugged plastic attachment: base foot dioptries: 3 and 12 lens diameter: 90 mm operating voltage: 230 V 12 W fluorescent ring (1 x included) 1.75 and 4 x zoom	1 piece
92-09988	replacement fluorescent ring	1 piece

<b>Lamp stand for magnifying lamp</b>			
	92-09982	height: 1 m, base with 4 reels	1 piece
		white	



REF

pack. unit

**Head magnifying glass**

---

92-09985 with dual light, power supply: 4 x 1.5 V AAA batteries (incl.)  
diopres: adjustable : 1.8/ 2.3/ 3.7/ 4.8

1 piece



**Magnifier**

REF

pack. unit



92-08509

magnifier for rigid endoscopes

1 piece

- 10 x zoom

**Hand microscope**

92-09990

1 piece

- digital hand microscope with computer connection (USB) with LED's
- with tripod base
- incl. software for screen output

resolution: 4.9 megapixels

power supply: per USB

system requirement: minimum Windows XP SP2

magnification: 1.5 - 200-times



**Angle mount for REF 09990, made of steel, height adjustable**  
**REF**

pack. unit

92-09991

1 piece

**Digital hand microscope with computer connection (USB) with LED's**

92-09998

incl. software for screen output

1 piece

resolution: 2.0 megapixels  
 with auto focus  
 power supply: per USB  
 system requirement: minimum Windows XP  
 magnification: 15~65-times, 225-times

**Angle mount for REF 09998, height adjustable**

92-09999

- 2-axis movable platform with stage clips
- adjustable LED light source (power by battery or USB port)

1 piece

**Digital caliper**

92-09800

- 6-digit jumbo LCD display
- measuring range 0 - 150 mm
- resolution 0.1 mm
- metric / inch change-over
- auto power-off function
- supply with two 1.55 V button cells
- stable box

1 piece



Indicator "Wash-Check"

REF		pack. unit
92-08554	the test soil simulates human blood and tissue residues, for validation of cleaning and disinfection process in washer-disinfector	10 pieces



Josafe CCI easy

92-50052	cleaning indicators for the routine monitoring of washer-disinfectors according to ISO 15883	18 pieces
----------	--	-----------

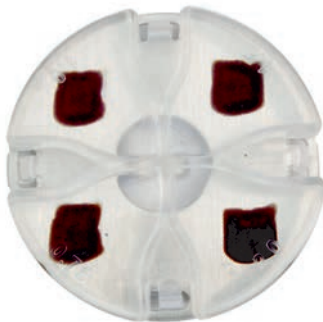

Batch control - STF Load Check for washer-disinfectors

	<p>The STF Load Check indicator and holder are intended for use inside each basket or tray to verify the cleaning efficacy of a surgical instrument in the washer-disinfector.</p> <p>The dried test soil formula, printed on both sides of the indicator, contains two sources of protein, lipids and polysaccharides and is formulated to mimic the cleaning efficacy soil tests for surgical instruments described in BS2745(9), ISO/TS 15883-5:2005(10) and UK Guidance Document HTM2030(11).</p> <p>Simply place an STF Load Check indicator in the holder, and place the device (indicator and holder) in the tray or basket. After running one complete cycle, remove the STF Load Check indicator from the holder and examine for evidence of residual soil. Complete removal of the dried 'test soil' pattern from the plastic substrate provides a qualitative assessment of the washer-disinfector cleaning performance.</p>	
92-50003	Load Check indicator 100 indicator strips / set	1 box
92-50004	Load Check holder	1 piece



**Batch control - Soil test for washer-disinfector**

REF

pack. unit

Inefficient cleaning can put disinfection and sterilization procedures at risk. A poorly functioning washer-disinfector can leave behind microscopic debris that can severely compromise both the disinfection and sterilization process. One of the best and easiest ways to check whether instruments are being cleaned effectively is to present the cleaning equipment with a physical challenge such as the cleaning efficacy tests described in BS2745(9), ISO/TS 15883-5:2005(10) and UK Guidance Document HTM2030(11).

The Browne Washer-Disinfector Test Soil is designed to simulate the soiling that naturally occurs during theatre use and performs in an equivalent manner to the Edinburgh soil. The Browne Soil Test is supplied in powder form as individual test pots. One pot, one test. Simply add water to the fill line, replace the cap, shake vigorously and apply to the test load with the brush provided. Following a 30-minute\*\* drying period at room temperature, the test load should be cleaned using normal procedures and then inspected for residual soil. Detailed instructions for use included in each box.

The bright red colour of the Browne Test Soil allows easy identification of areas that have not been properly cleaned, providing a visual analysis of equipment efficiency.

Non-toxic; contains no blood products.

\*\* Drying time should not exceed 2 hours.



92-50002 10 ready to use tests / box

1 box

**Quick protein test**

92-01420 Miele quick protein test for surgical instruments, set for 48 determinations

1 set



**Pro-Check indicator**



REF		pack. unit
92-08005	for control of cleaning and disinfection process of washer-disinfector and for control of surface cleaning procedure  50 swabs with 2 indicators / box (double ended swabs)	1 box

**pH-Test**



92-08018	pH test strip pH 1 - 14	50 pieces
----------	----------------------------	-----------

**pH-Tester 0.2 pH**



92-08505	<ul style="list-style-type: none"> <li>• range 0.00 - 14.00 pH</li> <li>• resolution 0.1 pH</li> <li>• accuracy +/- 0.1 pH</li> </ul>	1 piece
----------	---	---------

**Storage solution for electrodes (pH-Tester REF 92-08505)**



92-08525	content: 230 ml	1 bottle
92-08526	content: 500 ml	1 bottle

**Buffer solution pH 7 and pH 10 to calibrate the pH-Tester REF 92-08505**

REF pack. unit

92-08507 5 pouches pH 7 / 20 ml, 5 pouches pH 10 / 20 ml 1 pack



**Getinge Assured Wash Monitor**

92-03745 Ultrasonic Wash Monitor Holder for Wash Monitors 92-503865200 and 92-503864600 1 piece



92-503865200 Wash Monitor Ultrasonic 50 pieces



92-503864600 Wash Monitor 50 pieces



**Batch control class 2 / for steam sterilization - SMU-LC 121 °C / 134 °C**

92-08000 Sterilization Monitoring Unit-Load Control - Ready to use control system to monitor the steam sterilization process of hollow medical instruments 50 pieces

for steam sterilization  
sterilizing program: 121 °C / 134 °C

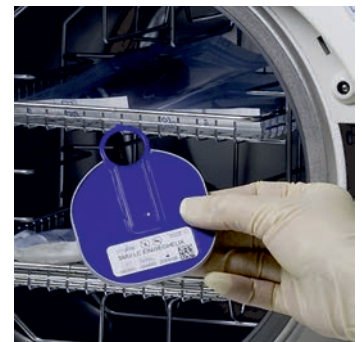

**Bowie & Dick multiple test pack for sterilizer with pulsed flow vacuum process**

REF

pack. unit



Routine monitoring for steam sterilization

- DIN A4
- without indicator
- for 20 applications

size: 220 x 295 mm

92-04200

clamping frame: TOLZIN

1 package

92-04202

clamping frame: HAWO

1 package

**Bowie & Dick multiple test pack for sterilizer with pulsed flow vacuum process**

92-04201

Routine monitoring for steam sterilization

1 package

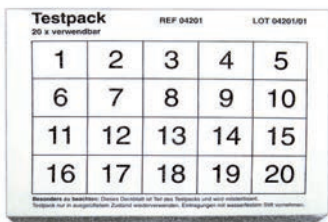

- DIN A6 Bowie & Dick
- without indicator
- for 20 applications

size: 106 x 148 mm

clamping frame: TOLZIN

**Routine monitoring - steam penetration test according to DIN EN ISO 11140**

REF		pack. unit
-----	--	------------

92-1001013	<ul style="list-style-type: none"> <li>• DIN A6 Bowie &amp; Dick-Simtest test sheet</li> <li>• pack: 50 indicator sheets / 50 laminated sheets</li> </ul>	1 package
------------	---	-----------

**Batch control - hot air indicator class 4 / thermotest H**

92-08001	<p>Indicator for hot air sterilization. The strips undergo a complete change of colour from white to brown depending on the time and temperature. A colour sample for an exposure time of 30 min. at 180 °C is enclosed in each package with the product information sheet.</p>	1 box
----------	---	-------

200 strips / box  
heat sterilization  
size: 10 x 60 mm

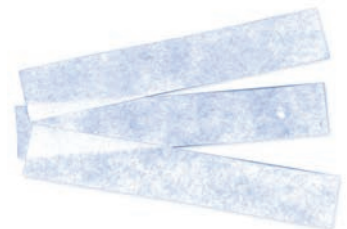
**Batch control - hot air indicator class 4 / thermocontrol**

92-08002	<p>Indicator for hot air sterilization, self-adhesive, with punch holes and perforation. To facilitate documentation, after sterilization the individual strips can be stuck onto the five documentation sheets supplied. A test strip for an exposure time of 30 min. at 180 °C makes it easier to evaluate the indicator.</p>	1 box
----------	---	-------

120 strips / box  
for steam sterilization  
size: 9 x 48 mm

**Batch control - steam control indicator - class 5**

92-08003	<p>Steam indicator for self-checking. Sterilization with saturated steam and at temperatures between 121 °C and 134 °C. Colour change from ochre-brown through grey to black. Size of individual indicator: 6 x 74 mm, single self-adhesive. Test strips supplied make it easier to evaluate the indicator after sterilization.</p>	1 box
----------	---	-------

200 strips / box, with test tube  
for steam sterilization



**Batch control - H<sub>2</sub>O<sub>2</sub> indicator (plasma)**  
REF

pack. unit



92-08102

colour change: from pink to yellow  
100 strips / box, with test tube  
for H<sub>2</sub>O<sub>2</sub> sterilization (plasma)  
self-adhesive

1 box

**Batch control - FO indicator - class 4**

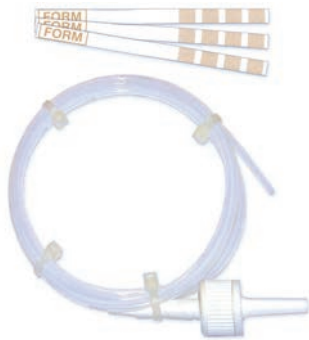

92-08006

Indicator for steam-formaldehyde sterilization;  
colour change depends on formaldehyde  
concentration, exposure time and operating  
temperature. Size of individual indicator: 6 x 74  
mm, single self-adhesive. Test strips supplied  
make it easier to evaluate the indicator after  
sterilization. Colour change from beige to violet.

1 box

200 strips / box, with test tube  
for FO sterilization

**Batch control - Three-Phase Sequential Indicator steam indicator - class 5**



92-08026

The blue indicator changes to black when exposed  
to steam but this change does not ensure the  
sterilization process' efficiency (UNSAFE). The pink  
indicator changes to black to obtain the stated  
values of the critical variables for class 5  
indicators. These values are obtained when the  
sterilizer is able to heat the steam at 134 °C for 3.5  
minutes or 15 minutes at 121 °C. This situation is  
named OK. Longer exposure times or higher  
temperatures can be determined when the green  
indicator changes to dark brown up to black. This  
situation is named OPTIMUM.

1 box

250 pcs. / box  
for steam sterilization  
sterilizing program: 134 °C / 3.5 min. | 121 °C / 15  
min.



**Batch control - Three-Phase Sequential Indicator steam indicator - class 6**

REF		pack. unit
-----	--	------------

92-08027	The blue indicator changes to black when exposed to steam but this change does not ensure the sterilization process' efficiency (UNSAFE). The green indicator changes to black when the sterilization process has achieved 134 °C for 5.3 minutes. This situation is named OK. Longer exposure times or higher temperatures can be determined when the yellow indicator changes to dark brown up to black. This situation is named OPTIMUM.	1 box
----------	---	-------

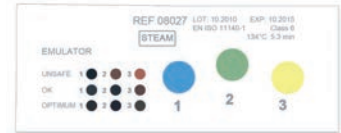

250 pcs. / box  
for steam sterilization

**Batch control - Des Check for moist heat processes**

Cycle verification indicators for use in moist heat processes.  
The Des Check range provides an accurate, convenient method of routine control for moist heat processes. When distributed throughout the load, the indicators provide visual confirmation of conditions achieved at point of placement. The vivid colour change from yellow to blue gives clear evidence of the conditions attained, thus allowing a quick and easy assessment of the success of the process.

Designed using advanced polymer technology to withstand conditions present during moist heat processes.

Des Check technology can be applied to different time and temperature combinations.

Store at or below 0 °C.

According to ISO 11140-1 class 6.

100 indicator strips / set  
sterilization for moist heat processes

92-50000	sterilizing program: 93 °C / 10 min.	1 box
92-50001	sterilizing program: 90 °C / 5 min.	1 box



**Batch control - TST Bowie & Dick single use test pack / for steam sterilization for small sterilizers type B and large sterilizers**

REF		pack. unit
92-50005	<p>A successful test confirms that steam penetration into a test pack is rapid and even and, by implication, that air and other non-condensable gases have been effectively removed. The chemical indicator sheet at the centre of the pack shows a defined colour change from yellow to dark blue / purple when exposed to a specific combination of time, temperature and steam. When there is no air or other non-condensable gases in the chamber, steam will penetrate the pack rapidly and completely and the indicator will show a uniform colour change. When air or other non-condensable gases are present they will collect towards the centre of the pack as an air / gas pocket which will impair contact between the steam and the indicator sheet. The temperature or moisture level (or both) will be lower in the region of the air / gas pocket and will result in a non-uniform colour change of the indicator; distinct yellow markings will be evident on the sheet.</p> <p>Matachana M20 – B According to EN 867 – 5.</p> <p>20 test packs / box for steam sterilization sterilizing program: 134 °C - 137 °C until 3.5 min.</p>	1 box

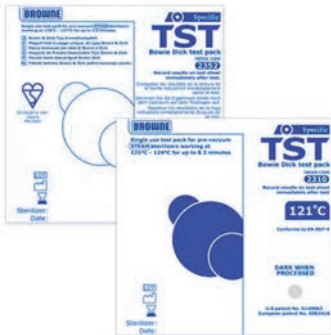
**Batch control - TST Helix control-strip for steam sterilization**

92-50010	<p>The Browne TST Helix is a Hollow Load Process Challenge Device (PCD) as defined in EN 867-5 and has been developed and validated for testing of small Type B steam sterilizers only. Use in any other sterilizer or with any other type of indicator, may give dangerously misleading results. A successful test confirms steam penetration through the helix and confirms by implication that air and other non-condensable gases have been removed.</p> <p>1 TST PCD and 250 indicator strips / set for steam sterilization</p>	1 set
----------	--	-------



**Batch control - TST Load Check for steam sterilization**  
 REF

pack. unit

	PCD and 400 indicator strips / set for steam sterilization	
92-50006	sterilizing program: 134 °C / 3.5 min.	1 set
92-50007	sterilizing program: 134 °C / 4.0 min. , 121 °C / 12 min.	1 set
92-50008	sterilizing program: 134 °C / 5.3 min. , 121 °C / 15 min.	1 set
92-50009	sterilizing program: 134 °C / 7.0 min. , 121 °C / 20 min.	1 set

**Batch control - Formaldehyde Load Check**

92-50014	200 indicator strips / set for FO sterilization	1 set
----------	--	-------



**Batch control - TST control indicator for steam sterilization**

The Browne TST Control™ Emulating Indicators are calibrated to the specific cycle parameters of your sterilizer and are independently tested to ISO 11140-1 Class 6 performance criteria.

92-2317AB	sterilizing program: 134 °C / 3,5 min. 200 pcs. / Box	1 box
92-2340AB	sterilizing program: 134 °C / 3,5 min. 100 pcs. / Box	1 box
92-3727AB	sterilizing program: 134 °C / 3,5 min. self-adhesive 100 pcs. / Box	1 box
92-2341AB	sterilizing program: 134 °C / 4,0 min. and 121 °C / 4,0 min. 100 pcs. / Box	1 box
92-2302AB	sterilizing program: 134 °C / 5,3 min. and 121 °C / 15,0 min. 200 pcs. / Box	1 box
92-3726AB	sterilizing program: 134 °C / 5,3 min. und 121 °C / 15,0 min. self-adhesive 100 pcs./ Box	1 box



## Batch control - TST control indicator for steam sterilization

REF		pack. unit	
92-3725AB	sterilizing program: 134 °C / 7,0 min. and 121 °C / 20,0 min. self-adhesive 200 pcs. / Box	1 box	
	92-3760AB	sterilizing program: 134 °C / 7,0 min. and 121 °C / 20,0 min. 200 pcs. / Box	1 box
	92-3706AB	sterilizing program: 134 °C / 18,0 min. 200 pcs. / Box	1 box
92-2375AB	sterilizing program: 134 °C / 4,0 min. and 121 °C / 12,0 min. 200 pcs. / Box	1 box	

## Batch control - Ethylene oxide integrating indicator

Ethylene Oxide Integrators should be placed inside each pack. The control indicator turns from red to green when adequate sterilizing conditions have been reached, giving the end-user assurance that adequate sterilizing conditions occurred at point of placement.

Ethylene Oxide Integrators will show a fail if the relative humidity level, gas concentration, temperature or duration of exposure fall outside of the specified limits.

- 900 mg Concentration (mg per litre)
- Temperature: 37 °C - 55 °C
- Time: 20 - 55 minutes
- Humidity: 40 - 60 %



- 600 mg Concentration (mg per litre)
- Temperature: 37 °C - 55 °C
- Time: 35 - 70 minutes
- Humidity: 40 - 60 %

It is recommended that Browne Ethylene Oxide Process Detector (Order Code 2421) Spots are placed on the outside of each pack to allow processed and unprocessed items to be identified at a glance. Note however that the spots are not calibrated for use as an 'in-pack' control indicator.

According to ISO 11140-1 class 5.

92-50017	for EO sterilization 100 indicator cards / box	1 box
----------	---	-------

**Batch control - Formaldehyde control-indicator**

REF	pack. unit
-----	------------

Formaldehyde Control Indicators should be used inside each pack to show that Low Temperature Steam and Formaldehyde gas (LTSF) have penetrated the pack in a sufficient quantity and for the correct length of time for sterilization to occur.

The control indicator turns from blue to a complete green when adequate sterilizing conditions have been reached.

It is recommended that Browne Formaldehyde Process Detector (Order Code 2402) Spots are placed on the outside of each pack to allow processed and unprocessed items to be identified at a glance.

Note that the spots are not calibrated to be used as an 'in-pack' control indicator.

According to ISO 11140-1 class 4.



92-50015	for FO sterilization 100 indicator strips / box	1 box
----------	--	-------

**Batch control - Detector spots for Formaldehyde and Ethylene oxide sterilization**

The self-adhesive spots should be placed on the outside of every pack being sterilized. The spots change colour after passing through the process allowing differentiation between processed and unprocessed loads.

Note: The spots do not act as a control and are not intended as a guide to the efficacy of the process.

According to ISO 11140-1 class 1.



92-50016	for FO sterilization 250 spots / box	1 box
92-50018	for EO sterilization 1000 spots / box	1 box

**Batch control - Sterilization control tubes for the fluid, steam and heat sterilization**

100 pcs. / box

92-50019	type 1 black spot sterilizing program: 121 °C / 15 min. for fluid sterilization	1 box
----------	--	-------

92-50020	type 2 yellow spot sterilizing program: 134 °C / 3 min. for steam sterilization*	1 box
----------	--	-------



**Batch control - Sterilization control tubes for the fluid, steam and heat sterilization**

REF		pack. unit
92-50021	type 3 green spot sterilizing program: 160 °C / 60 min. heat sterilization	1 box
92-50022	type 4 blue spot sterilizing program: 180 °C / 12 min. heat sterilization	1 box
92-50023	type 5 white spot sterilizing program: 160 °C / 120 min. and 180 °C / 35 min. heat sterilization	1 box



\* Browne recommends the use of TST Control™ Cycle Verification (Emulating) Indicators for monitoring porous load steam sterilization processes.

**Chisels / heavy duty / hex stock**

REF		pack. unit
	Made of stainless steel without plating or coating of any kind. Designed specifically for routine sterilization through thousands of cycles.	
	length x width	
92-10280	125 x 8 mm	1 piece
92-10281	138 x 10 mm	1 piece
92-10286	175 x 19 mm	1 piece
92-10283	300 x 12 mm	1 piece
92-10285	300 x 16 mm	1 piece
92-10288	300 x 19 mm, curved	1 piece

**Chisel with extra wide blade**

	Made of stainless steel without plating or coating of any kind. Designed specifically for routine sterilization through thousands of cycles.	
92-10291	blade: 75 mm length x width: 275 x 75 mm	1 piece

**Ice pick**

	Made of stainless steel without plating or coating of any kind. Designed specifically for routine sterilization through thousands of cycles.	
92-10289	handle: heat resistant nylon	1 piece



**Mallet**

REF

pack. unit



92-10190

Made of stainless steel without plating or coating of any kind.  
Designed specifically for routine sterilization through thousands of cycles.

weight: 12 oz. (340 g)  
with nylon head  
length: 317 mm

1 piece

**Ball pein hammer**

92-10198

Made of stainless steel without plating or coating of any kind.  
Designed specifically for routine sterilization through thousands of cycles.

weight: 6 oz. (170 g)  
length: 219 mm

1 piece



**Ball end hex keys, metric**

REF		pack. unit
	Made of stainless steel without plating or coating of any kind. Designed specifically for routine sterilization through thousands of cycles.	
92-11800	1.5 mm	1 piece
92-11801	2.0 mm	1 piece
92-11802	2.5 mm	1 piece
92-11803	3.0 mm	1 piece
92-11804	3.5 mm	1 piece
92-11805	4.0 mm	1 piece
92-11807	5.0 mm	1 piece
92-11808	6.0 mm	1 piece
92-11809	8.0 mm	1 piece
92-11810	10.0 mm	1 piece
92-11811	set of 10 (92-11800 - 92-11810)	1 kit
92-11812	set of 8 (92-11800 - 92-11808)	1 kit

**Ball end hex keys, inch**

	Made of stainless steel without plating or coating of any kind. Designed specifically for routine sterilization through thousands of cycles.	
92-11850	1/16"	1 piece
92-11851	5/64"	1 piece
92-11852	3/32"	1 piece
92-11853	7/64"	1 piece
92-11854	1/8"	1 piece
92-11855	9/64"	1 piece
92-11856	5/32"	1 piece
92-11857	3/16"	1 piece
92-11858	7/32"	1 piece
92-11859	1/4"	1 piece
92-11861	5/16"	1 piece
92-11862	3/8"	1 piece
92-11863	set of 12 (92-11850 - 92-11862)	1 kit
92-11864	set of 10 (92-11850 - 92-11859)	1 kit



**Hex ball drivers, inch**

	REF		pack. unit
	92-11874	handle: heat resistant nylon, 1/8" x 3.25"	1 piece
	92-21870	handle: steel, 1/16" x 2.5"	1 piece

Made of stainless steel without plating or coating of any kind.

Designed specifically for routine sterilization through thousands of cycles.

**Hex ball drivers with heat resistant nylon handle, metric**

	92-11820	1.5 mm x 62 mm	1 piece
	92-11822	2.5 mm x 62 mm	1 piece
	92-11823	3.0 mm x 62 mm	1 piece
	92-11824	3.5 mm x 100 mm	1 piece
	92-11825	4.0 mm x 87 mm	1 piece
	92-11827	5.0 mm x 100 mm	1 piece
	92-11828	6.0 mm x 112 mm	1 piece
	92-11829	8.0 mm x 137 mm	1 piece
	92-11830	10.0 mm x 150 mm	1 piece

Made of stainless steel without plating or coating of any kind.

Designed specifically for routine sterilization through thousands of cycles.

**Hex ball drivers with steel handle, metric**

	92-21820	1.5 mm x 62 mm	1 piece
	92-21821	2.0 mm x 62 mm	1 piece
	92-21822	2.5 mm x 62 mm	1 piece
	92-21823	3.0 mm x 62 mm	1 piece

Made of stainless steel without plating or coating of any kind.

Designed specifically for routine sterilization through thousands of cycles.



**Hex keys, L pattern, arm is 33 % longer than standard, metric**

	REF		pack. unit
	92-11941	set of 9 (92-11920 - 92-11928)	1 kit
	92-11913	set of 11 (92-11920 - 92-11930)	1 kit

**Fold-up hex key sets**

		Made of stainless steel without plating or coating of any kind. Designed specifically for routine sterilization through thousands of cycles.	
	92-12000	units: inch set of 9: 1/16", 5/64", 3/32", 7/64", 1/8", 9/64", 5/32", 3/16", 1/4"	1 piece
	92-12001	units: metric set of 7: 1.5, 2.0, 2.5, 3.0, 4.0, 5.0, 6.0 mm	1 piece

**Star / Hex lobe keys, L pattern**

		Made of stainless steel without plating or coating of any kind. Designed specifically for routine sterilization through thousands of cycles.		
	92-10809	#9	0.098" / 2.50 mm	1 piece
	92-10810	#10	0.107" / 2.74 mm	1 piece
	92-10811	#15	0.128" / 3.27 mm	1 piece
	92-10812	#20	0.151" / 3.86 mm	1 piece
	92-10813	#25	0.173" / 4.43 mm	1 piece
	92-10814	#27	0.195" / 4.99 mm	1 piece
	92-10815	#30	0.216" / 5.52 mm	1 piece
	92-10816	#40	0.260" / 6.65 mm	1 piece

**Star / Hex lobe drivers with stainless steel handle**

		Made of stainless steel without plating or coating of any kind. Designed specifically for routine sterilization through thousands of cycles.		
	92-10834	#9	0.098" / 2.50 mm	1 piece
	92-10835	#10	0.107" / 2.74 mm	1 piece
	92-10836	#15	0.128" / 3.27 mm	1 piece
	92-10837	#20	0.151" / 3.86 mm	1 piece
	92-10838	#25	0.173" / 4.43 mm	1 piece
	92-10839	#27	0.195" / 4.99 mm	1 piece
	92-10840	#30	0.216" / 5.52 mm	1 piece
	92-10841	#40	0.260" / 6.65 mm	1 piece

**1/4" Star / drive sockets for ratchets**

REF			pack. unit
		Made of stainless steel without plating or coating of any kind. Designed specifically for routine sterilization through thousands of cycles.	
92-10859	#9	0.098" / 2.50 mm	1 piece
92-10860	#10	0.107" / 2.74 mm	1 piece
92-10861	#15	0.128" / 3.27 mm	1 piece
92-10862	#20	0.151" / 3.86 mm	1 piece
92-10863	#25	0.173" / 4.43 mm	1 piece
92-10864	#27	0.195" / 4.99 mm	1 piece
92-10865	#30	0.216" / 5.52 mm	1 piece
92-10866	#40	0.260" / 6.65 mm	1 piece

**Nut drivers with heat resistant nylon handle, inch, total length: 8" (200 mm), set of 7**

		Made of stainless steel without plating or coating of any kind. Designed specifically for routine sterilization through thousands of cycles.	
92-10310	set of 7 (3/16", 1/4", 5/16", 3/8", 7/16", 1/2", 9/16")	handle: heat resistant nylon	1 kit

**Nut drivers with heat resistant nylon handle, metric, total length: 8" (200 mm)**

		Made of stainless steel without plating or coating of any kind. Designed specifically for routine sterilization through thousands of cycles.	
92-10323	10 mm	handle: heat resistant nylon	1 piece
92-10325	12 mm		1 piece
92-10330	set of 8 sizes: 6 - 8 mm and 10 - 14 mm		1 kit

**Nut driver with steel handle, inch, total length: 9" (225 mm)**

		Made of stainless steel without plating or coating of any kind. Designed specifically for routine sterilization through thousands of cycles.	
92-20301	1/4" total length: 9" (225 mm)	handle: steel	1 piece



**Nut drivers with steel handle, metric, total length: 9" (225 mm)**

REF		pack. unit
	Made of stainless steel without plating or coating of any kind. Designed specifically for routine sterilization through thousands of cycles.	
	handle: steel	
		
92-20323	10 mm	1 piece
92-20324	11 mm	1 piece
92-20325	12 mm	1 piece

**Two position pliers**

	Made of stainless steel without plating or coating of any kind. Designed specifically for routine sterilization through thousands of cycles.	
		
92-10010	length: 150 mm (6")	1 piece
92-10011	length: 250 mm (10")	1 piece

**Two position pliers, especially for sterile deployment**

	Made of stainless steel without plating or coating of any kind. Designed specifically for routine sterilization through thousands of cycles.	
		
92-10131	length: 200 mm (8")	1 piece

**Five position pliers, especially for sterile deployment**

	Made of stainless steel without plating or coating of any kind. Designed specifically for routine sterilization through thousands of cycles.	
		
92-10132	five position (chanellock) length: 250 mm (10")	1 piece

**Gripping pliers**

REF		pack. unit
	<p>Made of stainless steel without plating or coating of any kind. Designed specifically for routine sterilization through thousands of cycles.</p> <p>length: 125 mm (5")</p>	
92-10121	<p>long nose / straight straight serrated jaws spring loaded (removable) no cutter</p>	1 piece

**Locking pliers**

	<p>Made of stainless steel without plating or coating of any kind. Designed specifically for routine sterilization through thousands of cycles.</p>	
92-10014	<p>curved jaws critical series length: 125 mm (5")</p>	1 piece
92-10015	<p>straight jaws critical series length: 175 mm (7")</p>	1 piece



**Locking pliers**

	REF		pack. unit
	92-10016	straight jaws industrial series length: 250 mm (10")	1 piece
	92-10093	straight jaws industrial series / with adapter (thread) for slap hammer (REF 10094) length: 250 mm (10")	1 piece
	92-10017	long nose critical series length: 150 mm (6")	1 piece
	92-10018	long nose critical series length: 225 mm (9")	1 piece
	92-10019	long nose critical series length: 275 mm (11")	1 piece
	92-10029	curved jaws industrial series length: 200 mm (8")	1 piece
	92-10025	curved jaws industrial series length: 250 mm (10")	1 piece

**Locking pliers with slap hammer**



		Made of stainless steel without plating or coating of any kind. Designed specifically for routine sterilization through thousands of cycles.	
92-10028	with slap hammer 350 mm (14") straight jaws industrial series length: 250 mm (10")		1 piece

**Slap hammer**



		Made of stainless steel without plating or coating of any kind. Designed specifically for routine sterilization through thousands of cycles.	
92-10094	length: 350 mm (14")		1 piece



**Parallel jaw pliers, serrated jaws, with pin groove, with side cutter**

REF		pack.	unit
	Made of stainless steel without plating or coating of any kind. Designed specifically for routine sterilization through thousands of cycles.		
92-10013	length: 150 mm (6")	1	piece

**Drives with ratchet**

REF		pack.	unit
	Made of stainless steel without plating or coating of any kind. Designed specifically for routine sterilization through thousands of cycles.		
92-10496	torque rating: 300 in./lbs., 1/4" 162 mm long	1	piece
92-10596	torque rating: 500 in./lbs., 3/8" 212 mm long	1	piece

**Extensions for ratchet**

REF		pack.	unit
	Made of stainless steel without plating or coating of any kind. Designed specifically for routine sterilization through thousands of cycles.		
92-10492	50 mm (2") extension, 1/4" drive	1	piece
92-10493	100 mm (4") extension, 1/4" drive	1	piece
92-10593	100 mm (4") extension, 3/8" drive	1	piece
92-10594	150 mm (6") extension, 3/8" drive	1	piece

**1/4" Drive sockets, deep well, metric, length: 50 mm (2"), set of 9**  
REF

pack. unit



Made of stainless steel without plating or coating of any kind.  
Designed specifically for routine sterilization through thousands of cycles.

92-10489 sizes: 4 mm, 4.5 mm, 5 mm, 5.5 mm, 6 - 10 mm  
total length: 2" (50 mm) 1 kit

**3/8" Drive sockets, deep well, metric, length: 63 mm (2 1/2"), set of 12**



Made of stainless steel without plating or coating of any kind.  
Designed specifically for routine sterilization through thousands of cycles.

92-10634 sizes: 6 - 8 mm, 10 - 17 mm and 19 mm  
total length: 2.5" (63 mm) 1 kit

**3/8" Drive sockets, standard length, metric**



Made of stainless steel without plating or coating of any kind.  
Designed specifically for routine sterilization through thousands of cycles.

92-10520	6 mm	1 piece
92-10521	7 mm	1 piece
92-10526	13 mm	1 piece
92-10527	14 mm	1 piece
92-10528	15 mm	1 piece
92-10529	16 mm	1 piece
92-10530	17 mm	1 piece

**Drives without ratchet, with T-Bar**

REF		pack. unit
	Made of stainless steel without plating or coating of any kind. Designed specifically for routine sterilization through thousands of cycles.	
92-10597	1/4", 275 mm long	1 piece
92-10589	3/8", 100 mm long	1 piece
92-10588	1/2", 150 mm long	1 piece

**Bit screwdrivers and bits**

REF		pack. unit
92-11323	Phillips #2	1 piece
92-11324	Phillips #3	1 piece
92-11301	1/4" bit holder (with magnet)	1 piece

**Adjustable wrench**

	Made of stainless steel without plating or coating of any kind. Designed specifically for routine sterilization through thousands of cycles.	
92-10228	22 mm (7/8")	1 piece



**Adjustable spanner wrenches**

REF pack. unit

---

Made of stainless steel without plating or coating of any kind.

Designed specifically for routine sterilization through thousands of cycles.

92-10225	155 - 230 mm (6 1/8" - 9 1/8")
92-10226	sizes: 20 - 35 mm, 35 - 60 mm, 60 - 90 mm, 90 - 155 mm and 155 - 230 mm

1 piece  
1 kit



**Combination wrenches, inch**

---

Made of stainless steel without plating or coating of any kind.

Designed specifically for routine sterilization through thousands of cycles.

92-20134	1/4"
92-20136	3/8"
92-20137	7/16"
92-20138	1/2"
92-20139	9/16"

1 piece  
1 piece  
1 piece  
1 piece  
1 piece



**Combination wrenches made of special stainless steel**

REF

pack. unit



Made of stainless steel without plating or coating of any kind.  
Designed specifically for routine sterilization through thousands of cycles.

92-20034	5.5 mm	1 piece
92-20036	7 mm (special size)	1 piece
92-20041	10 mm	1 piece
92-20042	11 mm	1 piece
92-20044	12 mm	1 piece
92-20045	13 mm	1 piece
92-20047	14 mm	1 piece

**Open end wrenches, inch**

Made of stainless steel without plating or coating of any kind.  
Designed specifically for routine sterilization through thousands of cycles.

92-10135	3/8" x 7/16"	1 piece
92-10136	1/2" x 9/16"	1 piece
92-10139	7/8" x 15/16"	1 piece
92-10140	1" x 1 1/16"	1 piece

**Open end wrenches, metric** REF pack. unit

Made of stainless steel without plating or coating of any kind.  
Designed specifically for routine sterilization through thousands of cycles.



92-10035	6 x 7 mm	1 piece
92-10038	8 x 9 mm	1 piece
92-10041	10 x 11 mm	1 piece
92-10044	12 x 13 mm	1 piece
92-10047	14 x 15 mm	1 piece
92-10049	16 x 17 mm	1 piece
92-10057	30 x 32 mm	1 piece
92-10061	set of 9 (92-10035, 92-10038, 92-10041, 92-10044)	1 kit

**Screwdriver - set with wall holder, set of 6**

Made of stainless steel without plating or coating of any kind.  
Designed specifically for routine sterilization through thousands of cycles.

- 92-21224 Set consisting of:
- screwdriver - parallel tip: 3.0; 4.0; 5.5 and 6.5 mm
  - screwdriver - square drive: PH 1 and PH 2

1 set



**Hex key - set L pattern, with ball end, set of 9**

REF		pack. unit
92-11985	Made of stainless steel without plating or coating of any kind. Designed specifically for routine sterilization through thousands of cycles.  Set consisting of: • 1.5; 2; 2.5; 3; 4; 5; 6; 8 and 10 mm	1 set

**Scissors to cut tubes**

92-09060	length: 160 mm, blade and spring made of stainless steel, scissors made of plastic, lockable, easy to clean  white heat resistant: up to 134 °C washable in washer-disinfector	1 piece
----------	--	---------

**Scissors to cut tubes**

92-08510	Easy usage and secure cutting due to half-rounded overlay, teflon-plated blade, scissors made of plastic, easy cutting up to 1-inch tube-thickness  heat resistant: up to 134 °C washable in washer-disinfector	1 piece
----------	--	---------



## Kirschner wires - trocar - round made of stainless steel

REF	diameter x length	pack. unit
92-07005	1.2 x 60 mm TR/RD	10 pieces
92-07010	1.8 x 60 mm TR/RD	10 pieces
92-07018	0.8 x 100 mm TR/RD	10 pieces
92-07020	1.0 x 100 mm TR/RD	10 pieces
92-07022	1.2 x 100 mm TR/RD	10 pieces
92-07403	0.7 x 150 mm TR/RD	10 pieces
92-07404	0.8 x 150 mm TR/RD	10 pieces
92-07406	1.0 x 150 mm TR/RD	10 pieces
92-07408	1.2 x 150 mm TR/RD	10 pieces
92-07409	1.4 x 150 mm TR/RD	10 pieces
92-07410	1.5 x 150 mm TR/RD	10 pieces
92-07411	1.6 x 150 mm TR/RD	10 pieces
92-07412	1.7 x 150 mm TR/RD	10 pieces
92-07413	1.8 x 150 mm TR/RD	10 pieces
92-07414	1.9 x 150 mm TR/RD	10 pieces
92-07415	2.0 x 150 mm TR/RD	10 pieces
92-07416	2.2 x 150 mm TR/RD	10 pieces
92-07417	2.4 x 150 mm TR/RD	10 pieces
92-07418	2.5 x 150 mm TR/RD	10 pieces
92-07035	0.8 x 160 mm TR/RD	10 pieces
92-07036	0.9 x 160 mm TR/RD	10 pieces
92-07037	1.0 x 160 mm TR/RD	10 pieces
92-07038	1.1 x 160 mm TR/RD	10 pieces
92-07039	1.2 x 160 mm TR/RD	10 pieces
92-07040	1.4 x 160 mm TR/RD	10 pieces
92-07042	1.6 x 160 mm TR/RD	10 pieces
92-07044	1.8 x 160 mm TR/RD	10 pieces
92-07046	2.0 x 160 mm TR/RD	10 pieces
92-07047	2.2 x 160 mm TR/RD	10 pieces
92-07048	2.4 x 160 mm TR/RD	10 pieces
92-07049	2.5 x 160 mm TR/RD	10 pieces
92-07051	3.0 x 160 mm TR/RD	10 pieces
92-07052	0.8 x 310 mm TR/RD	10 pieces
92-07053	0.9 x 310 mm TR/RD	10 pieces
92-07054	1.0 x 310 mm TR/RD	10 pieces
92-07055	1.1 x 310 mm TR/RD	10 pieces
92-07056	1.2 x 310 mm TR/RD	10 pieces
92-07057	1.4 x 310 mm TR/RD	10 pieces
92-07058	1.5 x 310 mm TR/RD	10 pieces
92-07059	1.6 x 310 mm TR/RD	10 pieces
92-07061	1.8 x 310 mm TR/RD	10 pieces
92-07063	2.0 x 310 mm TR/RD	10 pieces
92-07064	2.2 x 310 mm TR/RD	10 pieces
92-07065	2.4 x 310 mm TR/RD	10 pieces
92-07066	2.5 x 310 mm TR/RD	10 pieces
92-07067	2.8 x 310 mm TR/RD	10 pieces
92-07068	3.0 x 310 mm TR/RD	10 pieces





**Kirschner wires - trocar - trocar made of stainless steel**  
 REF

pack. unit

diameter x length:

92-07174	0.6 x 70 mm TR/TR	10 pieces
92-07175	0.8 x 70 mm TR/TR	10 pieces
92-07117	0.8 x 100 mm TR/TR	10 pieces
92-07118	0.9 x 100 mm TR/TR	10 pieces
92-07119	1.0 x 100 mm TR/TR	10 pieces
92-07121	1.2 x 100 mm TR/TR	10 pieces
92-07122	1.4 x 100 mm TR/TR	10 pieces
92-07172	0.7 x 150 mm TR/TR	10 pieces
92-07173	0.8 x 150 mm TR/TR	10 pieces
92-07134	0.8 x 160 mm TR/TR	10 pieces
92-07136	1.0 x 160 mm TR/TR	10 pieces
92-07138	1.2 x 160 mm TR/TR	10 pieces
92-07139	1.4 x 160 mm TR/TR	10 pieces
92-07141	1.6 x 160 mm TR/TR	10 pieces
92-07143	1.8 x 160 mm TR/TR	10 pieces
92-07147	2.4 x 160 mm TR/TR	10 pieces
92-07148	2.5 x 160 mm TR/TR	10 pieces
92-07150	3.0 x 160 mm TR/TR	10 pieces
92-07155	1.2 x 310 mm TR/TR	10 pieces
92-07156	1.4 x 310 mm TR/TR	10 pieces
92-07158	1.6 x 310 mm TR/TR	10 pieces
92-07159	1.7 x 310 mm TR/TR	10 pieces
92-07160	1.8 x 310 mm TR/TR	10 pieces
92-07162	2.0 x 310 mm TR/TR	10 pieces
92-07163	2.2 x 310 mm TR/TR	10 pieces

**Kirschner wires - trocar - flat made of stainless steel**

diameter x length:

92-07233	3.0 x 100 mm TR/FL	10 pieces
92-07234	0.8 x 160 mm TR/FL	10 pieces
92-07235	0.9 x 160 mm TR/FL	10 pieces
92-07236	1.0 x 160 mm TR/FL	10 pieces
92-07238	1.2 x 160 mm TR/FL	10 pieces
92-07239	1.4 x 160 mm TR/FL	10 pieces
92-07241	1.6 x 160 mm TR/FL	10 pieces
92-07242	1.7 x 160 mm TR/FL	10 pieces
92-07243	1.8 x 160 mm TR/FL	10 pieces
92-07245	2.0 x 160 mm TR/FL	10 pieces
92-07255	1.2 x 310 mm TR/FL	10 pieces
92-07257	1.5 x 310 mm TR/FL	10 pieces
92-07259	1.7 x 310 mm TR/FL	10 pieces
92-07260	1.8 x 310 mm TR/FL	10 pieces
92-07262	2.0 x 310 mm TR/FL	10 pieces
92-07263	2.2 x 310 mm TR/FL	10 pieces
92-07264	2.4 x 310 mm TR/FL	10 pieces
92-07265	2.5 x 310 mm TR/FL	10 pieces
92-07267	3.0 x 310 mm TR/FL	10 pieces



**Kirschner wires - trocar with 15 mm thread - round made of stainless steel**

REF		pack. unit
92-07269	diameter x length: 1.0 x 160 mm TR/RD	10 pieces



**Kirschner wires - trocar with lengthwise knurl and special loop made of stainless steel**

92-07268	diameter x length: 2.4 x 430 mm TR/LR	10 pieces
----------	--	-----------



**Drill tip - round made of stainless steel**



92-07270	diameter x length: 2.4 x 310 mm	10 pieces
----------	------------------------------------	-----------



Also available: Kirschner wires made of pure titanium 5 TiAL6V4 (ELI).

**Container for kirschner wires made of stainless steel**

internal diameter: 10 mm  
laser print: possible

	92-07465	length: 100 mm	1 piece
	92-07400	length: 160 mm	1 piece
	92-07466	length: 180 mm	1 piece
	92-07467	length: 200 mm	1 piece
	92-07401	length: 240 mm	1 piece
	92-07468	length: 250 mm	1 piece
	92-07402	length: 320 mm	1 piece
	92-07421	length: 440 mm	1 piece

**Sleeve for kirschner wires with 4 chambers made of titanium**

REF

pack. unit

external diameter: 20 mm  
laser print: possible

92-07493 length: 130 mm  
92-07494 length: 200 mm  
92-07495 length: 350 mm

1 piece  
1 piece  
1 piece

**Mesh sleeve made of stainless steel**

diameter: 22 mm

92-07430 length: 170 mm, mesh size: 0.5 x 0.5 mm  
92-07431 length: 200 mm, mesh size: 0.8 x 0.8 mm  
92-07461 length: 330 mm, mesh size: 0.8 x 0.8 mm

1 piece  
1 piece  
1 piece

**Mesh sleeve made of stainless steel with 4 partitions for kirschner wires**

92-07460 with dispenser system for kirschner wires:  
Ø 0.8; 1.0; 1.2; 1.4 mm

1 piece

length: 170 mm  
mesh size: 0.5 x 0.5 mm  
internal diameter: 20 mm

**Dispenser for kirschner wires made of stainless steel**

adjustable in wire length, incl. hex key

wire length: for 150 - 310 mm

92-08441 wire diameter: for 0.8 - 2.0 mm  
92-08439 wire diameter: for 1.4 - 3.0 mm

1 piece  
1 piece



**Dispenser for kirschner wires made of stainless steel**

REF

pack. unit



92-08440

wire diameter: for 0.8 - 1.4 mm  
 wire length: for 150 mm  
 size: 166 x 72 x 40 mm

1 piece

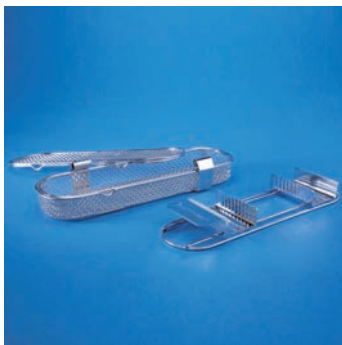
**Dispenser set for kirschner wires made of stainless steel**

92-08800

Set consisting of:

- 1 x small parts sieve tray 1/6
- 1 x lid for small parts sieve tray
- 1 x K-wire dispenser

wire length: for 150 mm

1 piece

**Caliper**

92-07500

diameter: 0.7 - 3.0 mm

1 piece



**Dishes made of cardboard**

REF		pack. unit
92-09218	size: 225 x 135 x 19 mm, meditainer: No. 73	840 pieces
92-09217	size: 180 x 136 x 20 mm, meditainer: No. 70	1200 pieces
92-09220	size: 180 x 90 x 19 mm, meditainer: No. 65	1240 pieces
92-09219	size: 260 x 135 x 19 mm, meditainer: No. 75	450 pieces
92-09222	size: 236 x 154 x 50 mm kidney dish	300 pieces

**Kidney dish made of polypropylene**

92-08216	blue size: 260 x 137 x 45 mm not resistant against acids and alkaline resistant against hot water heat resistant: up to 134 °C	5 pieces
----------	--	----------

**Disposable kidney dish made of plastic**

92-08241	white content: 700 ml	100 pieces
----------	--------------------------	------------

**Disposable kidney dish made of plastic, single packed, sterile**

92-08281	white content: 700 ml	35 pieces
----------	--------------------------	-----------





	heat resistant	
92-08230	height: 30 mm, content: 60 ml	2 pieces
92-08231	height: 40 mm, content: 120 ml	2 pieces
92-08232	height: 40 mm, content: 175 ml	2 pieces
92-08233	height: 50 mm, content: 235 ml	2 pieces

**Disposable bowls, non-sterile**

---



	stackable with graduation heat resistant: up to 134 °C	
	100 ml	
92-08240	transparent	100 pieces
92-08236	blue	100 pieces
92-08237	yellow	100 pieces
92-08238	red	100 pieces
92-08239	green	100 pieces
	150 ml	
92-08214	transparent	10 pieces
92-08203	blue	10 pieces
92-08204	yellow	10 pieces
92-08205	red	10 pieces

---

**Disposable bowls, non-sterile**

REF		pack. unit
92-08215	250 ml transparent	10 pieces
92-08206	blue	10 pieces
92-08207	yellow	10 pieces
92-08208	red	10 pieces
92-08209	500 ml blue	10 pieces
92-08255	blue	300 pieces
92-08210	1000 ml blue	10 pieces
92-08211	3000 ml blue	1 piece
92-08280	5000 ml blue, diameter x height: 350 x 130 mm	1 piece

**Disposable bowls, sterile single packed**



	with graduation heat resistant: up to 134 °C	
92-08227	500 ml blue	40 pieces
92-08228	1000 ml blue	35 pieces

**Disposable bowls set, sterile packed**

	with graduation blue	
92-08225	1 x 250 ml 2 x 500 ml	25 sets
92-08226	2 x 250 ml 2 x 500 ml 1 x 1000 ml	35 sets
92-08229	1 x 250 ml (blue) 1 x spatula 175 mm (white)	50 sets
92-08234	1 x 500 ml (blue) 1 x spatula 175 mm (white)	40 sets
92-08235	1 x 450 ml (blue) 1 x spatula 175 mm (white)	40 sets



**Spatula, for single use only made of polypropylene (PP)**

	REF		pack. unit
		sterilizable heat resistant: up to 134 °C	
	92-08213	natural colour, length: 175 mm	12 pieces
	92-08212	blue, length: 190 mm	50 pieces
	92-08217	white, length: 160 mm	50 pieces
			



**Disposable sharps container**

	REF		pack. unit
		yellow lid: transparent	
	92-26011	content: 1.0 litres diameter (top): 110 mm diameter (bottom): 85 mm height: 150 mm	100 pieces
	92-26012	content: 1.5 litres diameter (top): 140 mm diameter (bottom): 110 mm height: 150 mm	60 pieces
	92-26013	content: 3.0 litres diameter (top): 140 mm diameter (bottom): 120 mm height: 240 mm	30 pieces

**PRObox disposal box**

	REF		pack. unit
	92-09826	"PRObox" - disposal box for used needles and used scalpel blades with safety closure  heat resistant: up to 134 °C	500 pieces

**Disposal box abox®**

	REF		pack. unit
	92-09879	abox® 300 (without lid) blue length x width x height: 340 x 403 x 312 mm content: 30.0 litres	1 piece
	92-09880	abox® 500 (without lid) black length x width x height: 340 x 403 x 502 mm content: 50.0 litres	1 piece



**Disposal box abox<sup>®</sup>**

REF		pack. unit
92-09881	lid for REF 92- 09879 (abox <sup>®</sup> 300) and REF 92-09880 (abox <sup>®</sup> 500) yellow	1 piece

**Disposal boxes made of polypropylene**

	liquidproof with drop sieve washable in washer-disinfector up to 60 °C all sides lockable	
	length x width x height	
92-09845	151 x 108 x 69 mm, 0.6 litres, without handle	1 piece
92-09846	151 x 108 x 117 mm, 1.0 litres, without handle	1 piece
92-09847	151 x 108 x 185 mm, 1.8 litres, without handle	1 piece
92-09816	278 x 115 x 103 mm, 2.0 litres, without handle	1 piece
92-09817	297 x 152 x 118 mm, 3.4 litres, without handle	1 piece
92-09805	301 x 188 x 94 mm, 3.6 litres, without handle	1 piece
92-09806	295 x 230 x 106 mm, 4.8 litres, with handle	1 piece
92-09807	295 x 230 x 138 mm, 6.5 litres, with handle	1 piece
92-09818	295 x 230 x 203 mm, 10.0 litres, with handle	1 piece



**Disposal boxes made of polypropylene**

REF		pack. unit
92-09839	with sieve and drip tray	1 piece
	blue with lid length x width x height: 890 x 200 x 145 mm content: 12.0 litres	

**Boxes made of polypropylene**

REF		pack. unit	
	natural colour heat resistant: up to 134 °C inner dimensions: 290 x 225 x 125 mm		
92-17190	box made of PP, without lid	1 piece	

**Lids made of polypropylene**

REF		pack. unit	
	natural colour size: 290 x 225 mm heat resistant: up to 134 °C		
92-17188	lid for box made of PP lid: closed	1 piece	

**Soil sieves made of stainless steel**

REF		pack. unit	
	suitable for REF 92-17150, 92-17160, 92-17170, 92-17180, 92-17191 and 92-17192		
92-08458	size: 245 x 175 x 90 mm mesh size: 10.0 x 10.0 mm	1 piece	
92-08803	with handle size: 245 x 175 x 90 mm mesh size: 3.0 x 3.0 mm	1 piece	
92-08956	with handle size: 270 x 192 x 90 mm mesh size: 4.2 x 4.2 mm	1 piece	

**Plastic box made of polypropylene**

REF		pack. unit	
	heat resistant: up to 134 °C		
92-09838	transparent material thickness: 800 µ inner dimensions: 305 x 230 x 20 mm	120 pieces	

**Griffin beakers made of polypropylene**

	REF		pack. unit
		with graduation	
	92-06004	content: 250 ml	6 pieces
	92-06005	content: 400 ml	6 pieces
	92-06006	content: 500 ml	6 pieces

**Porcelain measuring beakers**

		with graduation	
	92-06018	content: 50 ml	1 piece
	92-06003	content: 100 ml	1 piece
	92-06001	content: 250 ml	1 piece
	92-06002	content: 500 ml	1 piece

**Plastic boxes e.g. for ident pearls or ident loops**

		transparent	
	92-09819	with 17 compartments size: 270 x 185 mm 42 mm	1 piece

**Impulse heat sealers**

REF		pack. unit
92-70000	F 70 stainless steel housing, with integrated roll holder and cutting device seal width: 8 mm seal length: 300 mm seal time indication by LED preselectable seal time	1 piece
92-70001	F 70 stainless steel housing, with integrated roll holder and cutting device seal width: 8 mm seal length: 400 mm seal time indication by LED preselectable seal time	1 piece

**Rotary heat sealers**

92-70002	F 108 standard stainless steel housing microprocessor controlled temperature adjustment (100 - 199 °C) temperature indication by LCD display manual operation of the transportation mechanism	1 piece
92-70003	F 108 T stainless steel housing temperature indication by LCD display manual operation of the transportation mechanism production counter with audible alarm	1 piece
92-70004	F 108 TI stainless steel housing temperature indication by LCD display automatically start of the transportation transportation release at reached temperature reverse transportation feature	1 piece
92-70005	F 108 TX stainless steel housing temperature indication by LCD display automatically start of the transportation transportation release at reached temperature reverse transportation feature production counter with alarm	1 piece



## Rotary heat sealers

	REF		pack. unit
	92-70006	F 110 stainless steel housing microprocessor controlled menu-operation LCD display automatically start of transportation reverse transportation feature standard	1 piece
	92-70007	F 110 D like F 110 + print packing date, expiry date and LOT-number alphanumeric keyboard adjustable print start position adjustable character width short and long expiry time EN 980 printing symbols	1 piece
	92-70008	F 110 DEP like F 110 D + printing text on packaging and labels interface for external label printer enter text with keyboard and interface RS 232 text memory on board disk with control instructions and null modem cable for PC	1 piece
	92-70009	F 110 DBC like F 110 DEP + print function: two lines print bar code (external software necessary) on packaging and labels communication with / or operation by PC disk with control instructions and null modem cable for PC	1 piece
	92-70010	F 220 D microprocessor controlled menu-operation LCD "All-clear" display "in-process"-controll for monitoring the temperature, force and feeding speed print packing date, expiry date and LOT-number selectable printing sequence EN 980 printing symbols alphanumeric keyboard	1 piece

## Rotary heat sealers

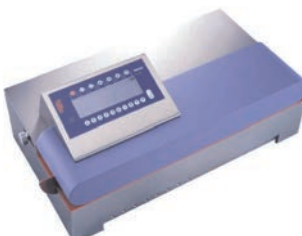
	92-70010	F 220 D microprocessor controlled menu-operation LCD "All-clear" display "in-process"-controll for monitoring the temperature, force and feeding speed print packing date, expiry date and LOT-number selectable printing sequence EN 980 printing symbols alphanumeric keyboard	1 piece
---	----------	--	---------

**Rotary heat sealers**

REF		pack. unit
92-70011	F 220 DEP like F 220 D + printing text on packaging and labels interface for external label printer enter text with keyboard and interface RS 232 text memory on board disk with control instructions and null modem cable for PC	1 piece
92-70012	F 220 DBC like F 220 DEP + print function: two lines print bar code (external software necessary) on packaging and labels communication with / or operation by PC communication port barcode reader disk with control instructions and null modem cable for PC	1 piece

**Steriking impulse sealer IS250**

92-70029	220 x 420 x 300 mm max. width: 250 mm max. seal-width: 8 mm Not suitable for gusseted packaging. User-friendly and economical sealer for all-day use. Constant sealing pressure, no warming-up time needed. Sealing technique according to DIN 58953-7. Automatic sealing time system with adjustable sealing duration, acoustic alert and signal lamp. Built-in roll holder and cutting device with rotating circular knife. Safety tested and approved by EN, VDE. Shock watch system for delivery safety.	1 piece
----------	--	---------

**Thermosealing machine "The Euroseal"**

92-70021	size: 440 x 200/420 x 300/390 mm with holders for 3 reels	1 piece
----------	--	---------



## SEAL PROOF

REF

pack. unit



To test rotary sealers  
 Deviations (sealing temperature, sealing pressure) are visible on the indicator.

1. Put the test sheet into your flat pouch.
2. Pass it through the sealer once.



92-08011

175 mm x 99 mm  
 for pouches made of paper / film

250 pieces

92-08022

175 mm x 99 mm  
 for pouches made of paper / film

50 pieces

92-08017

172 mm x 90 mm  
 for pouches made of tyvek

100 pieces



## STERIKING Seal Control



Sterilization packages have to be sealed to prevent the ingress of microorganisms and the sealing process needs to be validated accordingly. Under the new ISO standard 11607-2: 2006 users and processors are responsible to carry out a process validation program demonstrating the efficacy and reproducibility of all sterilization and packaging processes.

The Steriking® Seal Control sheet SC250 enables users to validate sealers and seal quality reliably and rapidly.

92-08021

size: 240 x 150 mm  
 simulation for pouches made of paper / film

250 pieces



**InkCheck**

REF

pack. unit

92-08101 Standard routine monitoring test method for detecting seal leaks, seal integrity test according to DIN EN ISO 11607-1, annex B / ASTM F1929 for the routine monitoring of your sealing device.

1 set





- according to DIN EN ISO 11607-1, annex B (ASTM F1929)
- ready for use ampule with 2 ml dye penetrant solution
- no complicated extraction/metering of the indicator liquid
- easy to open by Twist-off seal
- no spills / no splashes
- suitable for most of the common paper-/Tyvek®-packaging
- fast result / easy to interpret (5 seconds per seal)

Set consisting of:





- 50 tests à 2 ml
- magnifying card (REF 92-08529)

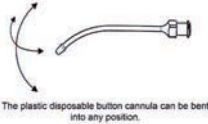



**Disposable button cannulas, made of plastic material, for topical wound irrigation, sterile**

REF			pack. unit
		operating length: 35 mm total length: 45 mm internal diameter: 0.8 mm	
92-05004		200 pieces PZN 02435819	
92-05053		50 pieces PZN 02497826	50 pieces
92-05023		21 pieces PZN 02497832	21 pieces
		operating length: 60 mm total length: 70 mm	
92-05000		150 pieces PZN 04954268	150 pieces
92-05050		50 pieces PZN 04954274	50 pieces
92-05021		21 pieces PZN 04954280	21 pieces
			
		operating length: 80 mm total length: 100 mm	
92-05002		150 pieces PZN 00424680	150 pieces
92-05052		50 pieces PZN 00425260	50 pieces
92-05022		21 pieces PZN 00426466	21 pieces



**Disposable cannulas, made of plastic material, blunt, for topical wound irrigation, sterile**

		operating length: 75 mm total length: 90 mm internal diameter: 1.0 mm	
92-05006		150 pieces PZN 01673540	150 pieces
92-05056		50 pieces PZN 01674479	50 pieces
92-05026		21 pieces PZN 01674485	21 pieces
			

**Disposable cannulas, made of plastic material, blunt, for topical wound irrigation, sterile**

		operating length: 35 mm total length: 55 mm internal diameter: 0.8 mm	
92-05008		200 pieces PZN 11161723	200 pieces
92-05058		50 pieces PZN 11161717	50 pieces
92-05028		21 pieces PZN 11161700	21 pieces



**Disposable button cannulas, made of plastic material, for topical wound irrigation, non-sterile**

REF		pack. unit	
92-05005	operating length: 35 mm total length: 45 mm internal diameter: 0.8 mm	150 pieces	
92-05001	operating length: 60 mm total length: 70 mm internal diameter: 0.8 mm	150 pieces	
92-05003	operating length: 80 mm total length: 100 mm internal diameter: 1.0 mm	150 pieces	

**Disposable cannulas, made of plastic material, blunt, for topical wound irrigation, non-sterile**

92-05007	operating length: 75 mm total length: 90 mm internal diameter: 1.0 mm	150 pieces	
----------	---	------------	---

**Disposable cannulas, made of plastic material, blunt, for topical wound irrigation, non-sterile**

92-05009	operating length: 35 mm total length: 55 mm internal diameter: 0.8 mm	200 pieces	 
----------	---	------------	---

**Disposable metal button cannulas, sterile**

92-05013	operating length: 80 mm external diameter: 0.8 mm external button diameter: 1.4 mm total length: 95 mm internal diameter: 0.4 mm	100 pieces	
92-05011	operating length: 100 mm external diameter: 1.0 mm external button diameter: 1.6 mm total length: 115 mm	100 pieces	

**Disposable metal cannulas, blunt, sterile**

REF		pack. unit
	operating length: 80 mm total length: 95 mm	
	92-05016 external diameter: 1.5 mm	100 pieces
	92-05036 external diameter: 2.5 mm	100 pieces
	92-05035 external diameter: 2.8 mm	100 pieces

**Disposable metal cannulas, curved, blunt, sterile**

	92-05030 operating length: 100 mm external diameter: 0.6 mm (23G) total length: 115 mm	100 pieces
	92-05031 operating length: 100 mm external diameter: 0.8 mm (21G) total length: 115 mm	100 pieces
	92-05032 operating length: 80 mm external diameter: 1.0 mm (19G) total length: 95 mm	100 pieces
	92-05033 operating length: 90 mm external diameter: 1.0 mm (19G) total length: 105 mm	100 pieces
	92-05034 operating length: 90 mm external diameter: 1.5 mm (17G) total length: 105 mm	50 pieces
	92-05042 operating length: 80 mm external diameter: 1.6 mm (14G) total length: 95 mm	50 pieces
	92-05043 operating length: 80 mm external diameter: 1.8 mm (13G) total length: 95 mm	50 pieces
	92-05044 operating length: 80 mm external diameter: 2.0 mm (12G) total length: 95 mm	50 pieces
	92-05045 operating length: 80 mm external diameter: 2.4 mm total length: 95 mm	50 pieces

**Pierce-Proof Sharps Pad, single packed, sterile**  
 REF

pack. unit

The puncture-resistant sharps pad helps to safely dispose used surgical sharps, including items such as scalpel blades, suture needles, cannula etc. The pads are self-sealing once closed which shields staff from exposed surgical sharps when handling for disposal.

92-26304

size: 145 x 120 mm

200 pieces

**Needle counter**

 92-26208 with 1 magnet and foam inlay  
 20-fold

100 pieces

 92-26209 with 2 magnets  
 20-fold

100 pieces

**MagnoMat - magnetic OR-mat**

For secure deposition, transfer and organization of instruments (made of metal) in the OR. Reduces the risk of sharps injuries.

92-300-400

size: 300 x 400 mm

3 piece

**Disposable hand scrub brush "surgical scrub" with sponge and nailcleaner, sterile**

- with sponge and nailcleaner
  - incl. velcro for wall mounting
  - 40 pcs. / dispenser
- dry (without detergent solution)

92-09391

240 pieces



**Disposable hand scrub brush "Medi Scrub" with sponge and nailcleaner, sterile**  
 REF

pack. unit



- with sponge and nailcleaner
- 25 pcs. / dispenser

92-09323	dry (without detergent solution)	375 pieces
92-09337	with 1.1% iodine in detergent solution	375 pieces
92-09367	with 4% chlorhexidine gluconate in detergent solution	375 pieces

**Holder for brush-dispenser, made of stainless steel, for Mediscrub dispenser (REF 92-09323, 92-09337, 92-09367)**

92-09347	for disposable hand scrub brush "Medi-Scrub"	1 piece
----------	--	---------

**Holder for brush-dispenser for disposable hand scrub brush (REF 92-09391)**

92-09203	material: stainless steel	1 piece
----------	---------------------------	---------

**Scrub brushes, non-sterile (not suitable for dispensers REF 92-09329 and 92-09330)**

92-09321	heat resistant: up to 134 °C washable in washer-disinfector: no hardness of the bristles: middle handle of brushes: with stable hollow handle	14 pieces
----------	--	-----------

**Scrub brushes, non-sterile**

REF		pack. unit
	heat resistant: up to 134 °C washable in washer-disinfector: no hardness of the bristles: soft handle of brushes: with stable hollow handle and integrated nailbrush	
92-09357	not suitable for dispensers REF 92-09329 and 92-09330	14 pieces
92-09327	suitable for brush dispensers REF 92-09329 and 92-09330	12 pieces

**Scrub brushes, non-sterile (suitable for dispensers REF 92-09329 and 92-09330)**

92-09328	heat resistant: up to 134 °C washable in washer-disinfector: no hardness of the bristles: soft handle of brushes: with open back	6 pieces
----------	---	----------

**Brush dispenser made of stainless steel (only for REF 92-09327 and 92-09328)**

	incl. fixation screws	
92-09329	size: 543 x 75 x 130 mm for 12 brushes REF 92-09327 or 18 brushes REF 92-09328	1 piece
92-09330	size: 695 x 75 x 130 mm for 16 brushes REF 92-09327 or 24 brushes REF 92-09328	1 piece

**Safety pins, sterile**

	2 pcs. sterile packing 50 x 2 pcs. / box	
92-06007	length: 25 mm	1 box
92-06008	length: 38 mm	1 box
92-06009	length: 50 mm	1 box



**Vessel Loops, 10 x 2 silicone ribbons of 45 cm, mini, sterile**

REF

pack. unit



		loops / box: 20 pieces size: 1.5 x 1.0 mm length: 45 cm profile: oval	
92-41210	blue		1 box
92-41220	red		1 box
92-41230	white		1 box
92-41240	yellow		1 box

**Vessel Loops, 10 x 2 silicone ribbons of 45 cm, maxi, sterile**

		loops / box: 20 pieces size: 2.5 x 1.0 mm length: 45 cm profile: oval	
92-41110	blue		1 box
92-41120	red		1 box
92-41130	white		1 box
92-41140	yellow		1 box

**Vessel Loops, 10 x 2 silicone ribbons of 45 cm, super-maxi - blue, sterile**

		loops / box: 20 pieces size: 5.0 x 1.5 mm length: 45 cm profile: oval	
92-41000	blue		1 box



**Suture aid booties, single use only, sterile**

REF		pack. unit
	<p>Suture aid booties protect, tag, and help to locate sutures - Our vinyl suture booties are available in two-, three-, or five-pair configuration and are positioned in an adhesive-backed foam block for quick and easy use. They are radiopaque, latex free, in sterile package for single-use. Choose from a variety of sizes and colours as listed below.</p>	
92-42020	yellow / standard 5 trays / 5 pairs each 50 pieces / box	1 box
92-42021	pink / large 5 trays / 5 pairs each 50 pieces / box	1 box
92-42022	red / standard 5 trays / 5 pairs each 50 pieces / box	1 box
92-42023	blue / standard 5 trays / 5 pairs each 50 pieces / box	1 box
92-42024	white / standard 5 trays / 5 pairs each 50 pieces / box	1 box
92-42025	assorted (yellow, red, white, blue) 5 trays / 5 pairs each 50 pieces / box	1 box
92-42028	yellow / standard 5 trays / 3 pairs each 30 pieces / box	1 box



## Clamp cushions made of silicone, sterile

REF

pack. unit



length: 125 mm

92-42001  
92-42002  
92-42003

content / box: 40 booties, 1/10" mini / red  
content / box: 40 booties, 2/10" midi / white  
content / box: 20 booties, 3/10" maxi / blue

1 box  
1 box  
1 box

## Carrying bag for patients property



92-03016

quadrilingual: German, English, French, Italian

250 pieces

with imprint: PATIENTENEIGENTUM / PATIENTS  
PROPERTY / AFFAIRES PERSONNELLES DU  
PATIENT / EFFETTI PERSONALI DEL PAZIENTE -  
Name / name / nom / nome: - Adresse / address /  
adresse / indirizzo: - Zimmer / room / chambre /  
camera:

size: 585 x 605 x 0.05 mm

material: LDPE

## Bag with flap for valuables



92-03038

quadrilingual: German, English, French, Italian

1000 pieces

black

with imprint: ACHTUNG WERTSACHEN /  
ATTENTION VALUABLES / ATTENTION OBJETS DE  
VALEUR / ATTENZIONE OGGETTI DI VALORE

with permanent adhesion

size: 200 x 300 + 50 mm flap

material: LDPE

## Bag with flap for dental prothesis



92-03021

quadrilingual: German, English, French, Italian

500 pieces

yellow

with imprint: Achtung: Zahnprothese / Attention:  
dental prothesis / Attention: prothèse dentaire /  
Attenzione: protesi dentaria - NAME / NAME /  
NOM / COGNOME - ADRESSE / ADDRESS /  
ADRESSE / INDIRIZZO

with permanent adhesion

size: 165 x 240 x 45 mm flap

material: LDPE

**Suture bag**

REF		pack. unit	
92-09093	steam sterilizable glue  heat resistant: up to 140 °C without imprint size: 190 + 105 x 275 mm material: made of smooth bleached strong paper 80 g/m <sup>2</sup>	450 pieces	

**Waste bag**

92-09094	dyed white with adhesive tape on the back size: 220 x 240 + 40 mm flap material: LDPE	1000 pieces	
----------	--	-------------	--

**Rigid light handle cover**

92-06014	sterile, 24 pcs. / box	1 box	
----------	------------------------	-------	---

**Flexible light handle covers**

92-06015	sterile, 100 pcs. / box	1 box	
92-06016	sterile, 80 x 2 pcs. / box	1 box	
92-06017	sterile, 80 x 3 pcs. / box	1 box	

**Display with imprint "Team Time out"**

	REF		pack. unit
	92-04217	imprint: team time out size: 270 x 70 mm material: made of heat resistant carton	75 pieces
	92-04220	non-sterile packing sterile packing	50 pieces

**Display made of stainless steel**

	92-20435	size: 140 x 60 x 53 mm surface: silk-matt glossy brushed imprint: team time out	1 piece
	92-20436	without imprint	1 piece
	92-00093	lettering single line	1 piece
	92-00094	lettering 2 lines	1 piece

**Disposable CPE pillow case cover**

	92-26009	blue size: 60 x 60 cm	250 pieces
---	----------	--------------------------	------------

**Bed label**

	92-09210	with 2 bevelled corners, metal eyelet with attached rubber cord  without imprint size: 58 x 110 mm	750 pieces
---	----------	--	------------

**Bed identification label**

REF		pack. unit
92-09141	100 sheets / pad size: 105 x 58 mm	100 pads

**Disposable ERCP-Trolley drape, sterile**

	with a backside adhesive strip for fixing size: 750 x 900 mm		
92-26041	with 3 pockets, transparent on a viscose non-woven	10 pieces	
92-26042	with 4 pockets, transparent on a viscose non-woven	10 pieces	

**Fixing hand made of stainless steel**

92-20600	lead-free heat resistant reusable and bentable	1 piece	
----------	--	---------	---

**Silicone ring Ø 18 x 3.5 mm, suitable for fixing hand made of stainless steel (REF 20600)**

92-09611	heat resistant size: 18 mm Ø x 3.5 mm	25 pieces	
----------	--	-----------	---



# ACCESSORIES FOR CSSD



Ermis®



Ermis MedTech GmbH  
Dornierstraße 49  
78532 Tuttlingen  
Tel: +49 (0) 7461/964857-0  
Fax: +49 (0) 7461/964857-99  
info@ermis-medizintechnik.de



V05

[www.ermis-medizintechnik.de](http://www.ermis-medizintechnik.de)

Nachdruck, auch auszugsweise, verboten.  
Reprinting even partially is not allowed.